

# HEIKO

Thermal 6  
Thermal 9  
Thermal 12



## DC Inverter Air to Water Heat Pump



# User's manual

Before operating this product, please read the instructions carefully and keep this manual for future use.

This product may only be installed or serviced by qualified personnel.

This appliance is filled with R32 refrigerant.

# Catalogue

|   |           |
|---|-----------|
| <b>1. Before use</b> .....                        | <b>4</b>  |
| 1.1 Safety precautions .....                      | 10        |
| 1.2 Working principle .....                       | 12        |
| 1.3 Main components .....                         | 13        |
| 1.4 Specifications .....                          | 15        |
| <br>  |           |
| <b>2. Assembly Configurations</b> .....           | <b>16</b> |
| 1. Flowchart .....                                | 16        |
| 2. Drawing 1 .....                                | 17        |
| 3. Drawing 2 .....                                | 19        |
| 4. Drawing 3 .....                                | 22        |
| 5. Drawing 4 .....                                | 25        |
| 6. Drawing 5 .....                                | 28        |
| 7. Drawing 6 .....                                | 31        |
| 8. Drawing 7 .....                                | 34        |
| 9. Drawing 8 .....                                | 37        |
| 10. Drawing 9 .....                               | 40        |
| 11. Drawing 10 .....                              | 43        |
| <br>  |           |
| <b>3. Installation</b> .....                      | <b>46</b> |
| 3.1 General application system introduction ..... | 46        |
| 3.2 Tools needed .....                            | 53        |
| 3.3 Installation of the indoor control unit ..... | 53        |
| 3.4 Installation of the monoblock unit .....      | 55        |
| 3.5 Accessories .....                             | 57        |
| 3.6 Wiring .....                                  | 58        |
| 3.7 Installation of safety valve kit .....        | 71        |
| 3.8 Water pipe connection .....                   | 72        |
| 3.9 Test run .....                                | 73        |
| <br>  |           |
| <b>4. Usage</b> .....                             | <b>74</b> |
| 4.1 Introduction of operation panel .....         | 74        |
| 4.2 Operation instruction .....                   | 79        |
| 4.3 Electric heater .....                         | 104       |
| 4.4 Failure codes .....                           | 105       |

# Catalogue

---

|  |            |
|--|------------|
| <b>5. Maintenance</b> .....  | <b>110</b> |
| 5.1 Precaution of maintenance for units with flammable refrigerant ..... | 110        |
| 5.2 Attention .....  | 113        |
| 5.3 Cleaning of water filter .....                                       | 113        |
| 5.4 Cleaning of plate heat exchanger .....                               | 113        |
| 5.5 Gas charging .....   | 113        |
| 5.6 Condenser coil .....   | 115        |
| 5.7 Service of indoor control unit .....                                 | 115        |
| 5.8 Service of monoblock unit .....                                      | 117        |
| <br>   |            |
| <b>6. Attached drawing</b> .....   | <b>121</b> |
| 6.1 Outlines and dimensions .....  | 121        |
| 6.2 Exploded view .....  | 123        |
| 6.3 Wiring diagram .....   | 125        |
| 6.4 Appendix A:Wiring .....  | 128        |

# 1. Before use

## 1.1 Safety precautions

### Cautions:

1. Do not use means to accelerate the defrosting process or to clean, other than those recommended by the manufacturer.
2. The appliance shall be stored in a room without continuously operating ignition sources (for example: open flames, an operating gas appliance or an operating electric heater.).
3. Do not pierce or burn.
4. Be aware that refrigerants may not contain an odour.
5. Appliance shall be installed, operated and stored in a room with a floor area larger than X m<sup>2</sup> (refer to specifications sheet).
6. The installation of pipe-work shall be kept to a minimum X m<sup>2</sup> (refer to specifications sheet).
7. Spaces where refrigerant pipes shall be compliance with national gas regulations.
8. Servicing shall be performed only as recommended by the manufacturer.
9. The appliance shall be stored in a well-ventilated area where the room size corresponds to the room area as specified for operation.
10. All working procedure that affects safety means shall only be carried by competent persons.

### General Notice:

#### 1. Transport of equipment containing flammable refrigerants

Compliance with the transport regulations

#### 2. Marking of equipment using signs

Compliance with local regulations

#### 3. Disposal of equipment using flammable refrigerants

Compliance with national regulations

#### 4. Storage of equipment/appliances

The storage of equipment should be in accordance with the manufacturer's instructions.

#### 5. Storage of packed (unsold) equipment

Storage package protection should be constructed such that mechanical damage to the equipment inside the package will not cause a leak of the refrigerant charge.

The maximum number of pieces of equipment permitted to be stored together will be determined by local regulations.

#### 6. Information on servicing

##### 1) Checks to the area

Prior to beginning work on systems containing flammable refrigerants, safety checks are necessary to ensure that the risk of ignition is minimised. For repair to the refrigerating system, the following precautions shall be complied with prior to conducting work on the system.

##### 2) Work procedure

Work shall be undertaken under a controlled procedure so as to minimise the risk of a flammable gas or vapour being present while the work is being performed.

# 1. Before use

## 3) General work area

All maintenance staff and others working in the local area shall be instructed on the nature of work being carried out. Work in confined spaces shall be avoided. The area around the workspace shall be sectioned off. Ensure that the conditions within the area have been made safe by control of flammable material.

## 4) Checking for presence of refrigerant

The area shall be checked with an appropriate refrigerant detector prior to and during work, to ensure the technician is aware of potentially flammable atmospheres. Ensure that the leak detection equipment being used is suitable for use with flammable refrigerants, i.e. non-sparking, adequately sealed or intrinsically safe.

## 5) Presence of fire extinguisher

If any hot work is to be conducted on the refrigeration equipment or any associated parts, appropriate fire extinguishing equipment shall be available to hand. Have a dry powder or CO<sub>2</sub> fire extinguisher adjacent to the charging area.

## 6) No ignition sources

No person carrying out work in relation to a refrigeration system which involves exposing any pipe work that contains or has contained flammable refrigerant shall use any sources of ignition in such a manner that it may lead to the risk of fire or explosion. All possible ignition sources, including cigarette smoking, should be kept sufficiently far away from the site of installation, repairing, removing and disposal, during which flammable refrigerant can possibly be released to the surrounding space. Prior to work taking place, the area around the equipment is to be surveyed to make sure that there are no flammable hazards or ignition risks. "No Smoking" signs shall be displayed.

## 7) Ventilated area

Ensure that the area is in the open or that it is adequately ventilated before breaking into the system or conducting any hot work. A degree of ventilation shall continue during the period that the work is carried out. The ventilation should safely disperse any released refrigerant and preferably expel it externally into the atmosphere.

## 8) Checks to the refrigeration equipment

Where electrical components are being changed, they shall be fit for the purpose and to the correct specification. At all times the manufacturer's maintenance and service guidelines shall be followed. If in doubt consult the manufacturer's technical department for assistance. The following checks shall be applied to installations using flammable refrigerants:

- The charge size is in accordance with the room size within which the refrigerant containing parts are installed;
- The ventilation machinery and outlets are operating adequately and are not obstructed;
- If an indirect refrigerating circuit is being used, the secondary circuit shall be checked for the presence of refrigerant;
- Marking to the equipment continues to be visible and legible. Markings and signs that are illegible shall be corrected;
- Refrigeration pipe or components are installed in a position where they are unlikely to be exposed to any substance which may corrode refrigerant containing components, unless the components are constructed of materials which are inherently resistant to being corroded or are suitably protected against being so corroded.

# 1. Before use

## 9) Checks to electrical devices

Repair and maintenance to electrical components shall include initial safety checks and component inspection procedures. If a fault exists that could compromise safety, then no electrical supply shall be connected to the circuit until it is satisfactorily dealt with. If the fault cannot be corrected immediately but it is necessary to continue operation, an adequate temporary solution shall be used. This shall be reported to the owner of the equipment so all parties are advised.

Initial safety checks shall include:

- .That capacitors are discharged: this shall be done in a safe manner to avoid possibility of sparking;
- .That there no live electrical components and wiring are exposed while charging, recovering or purging the system;
- .That there is continuity of earth bonding.

## 7.Repairs to sealed components

1)During repairs to sealed components, all electrical supplies shall be disconnected from the equipment being worked upon prior to any removal of sealed covers, etc. If it is absolutely necessary to have an electrical supply to equipment during servicing, then a permanently operating form of leak detection shall be located at the most critical point to warn of a potentially hazardous situation.

2) Particular attention shall be paid to the following to ensure that by working on electrical components, the casing is not altered in such a way that the level of protection is affected. This shall include damage to cables, excessive number of connections, terminals not made to original specification, damage to seals, incorrect fitting of glands, etc.

Ensure that apparatus is mounted securely.

Ensure that seals or sealing materials have not degraded such that they no longer serve the purpose of preventing the ingress of flammable atmospheres. Replacement parts shall be in accordance with the manufacturer's specifications.

NOTE: The use of silicon sealant may inhibit the effectiveness of some types of leak detection equipment. Intrinsically safe components do not have to be isolated prior to working on them.

## 8.Repair to intrinsically safe components

Do not apply any permanent inductive or capacitance loads to the circuit without ensuring that this will not exceed the permissible voltage and current permitted for the equipment in use.

Intrinsically safe components are the only types that can be worked on while live in the presence of a flammable atmosphere. The test apparatus shall be at the correct rating.

Replace components only with parts specified by the manufacturer. Other parts may result in the ignition of refrigerant in the atmosphere from a leak.

# 1. Before use

## 9.Cablling

Check that cabling will not be subject to wear, corrosion, excessive pressure, vibration, sharp edges or any other adverse environmental effects. The check shall also take into account the effects of aging or continual vibration from sources such as compressors or fans.

## 10.Detection of flammable refrigerants

Under no circumstances shall potential sources of ignition be used in the searching for or detection of refrigerant leaks. A halide torch (or any other detector using a naked flame) shall not be used.

## 11.Leak detection methods

The following leak detection methods are deemed acceptable for systems containing flammable refrigerants.

Electronic leak detectors shall be used to detect flammable refrigerants, but the sensitivity may not be adequate, or may need re-calibration. (Detection equipment shall be calibrated in a refrigerant-free area.) Ensure that the detector is not a potential source of ignition and is suitable for the refrigerant used. Leak detection equipment shall be set at a percentage of the LFL of the refrigerant and shall be calibrated to the refrigerant employed and the appropriate percentage of gas (25% maximum) is confirmed.

Leak detection fluids are suitable for use with most refrigerants but the use of detergents containing chlorine shall be avoided as the chlorine may react with the refrigerant and corrode the copper pipe-work.

If a leak is suspected, all naked flames shall be removed/ extinguished.

If a leakage of refrigerant is found which requires brazing, all of the refrigerant shall be recovered from the system, or isolated (by means of shut off valves) in a part of the system remote from the leak. Oxygen free nitrogen (OFN) shall then be purged through the system both before and during the brazing process.

## 12.Removal and evacuation

When breaking into the refrigerant circuit to make repairs – or for any other purpose –conventional procedures shall be used. However, it is important that best practice is followed since flammability is a consideration. The following procedure shall be adhered to:

- Remove refrigerant;
- Purge the circuit with inert gas;
- Evacuate;
- Purge again with inert gas;
- Open the circuit by cutting or brazing.

The refrigerant charge shall be recovered into the correct recovery cylinders. The system shall be “flushed” with OFN to render the unit safe. This process may need to be repeated several times. Compressed air or oxygen shall not be used for this task.

Flushing shall be achieved by breaking the vacuum in the system with OFN and continuing to fill until the working pressure is achieved, then venting to atmosphere, and finally pulling down to a vacuum. This process shall be repeated until no refrigerant is within the system. When the final OFN charge is used, the system shall be vented down to atmospheric pressure to enable work to take place. This operation is absolutely vital if brazing operations on the pipe-work are to take place. Ensure that the outlet for the vacuum pump is not close to any ignition sources and there is ventilation available.

# 1. Before use

## 13. Charging procedures

In addition to conventional charging procedures, the following requirements shall be followed.

- Ensure that contamination of different refrigerants does not occur when using charging equipment. Hoses or lines shall be as short as possible to minimise the amount of refrigerant contained in them.
- Cylinders shall be kept upright.
- Ensure that the refrigeration system is earthed prior to charging the system with refrigerant.
- Label the system when charging is complete (if not already).
- Extreme care shall be taken not to overfill the refrigeration system.

Prior to recharging the system it shall be pressure tested with OFN. The system shall be leak tested on completion of charging but prior to commissioning. A follow up leak test shall be carried out prior to leaving the site.

## 14. Decommissioning

Before carrying out this procedure, it is essential that the technician is completely familiar with the equipment and all its detail. It is recommended good practice that all refrigerants are recovered safely. Prior to the task being carried out, an oil and refrigerant sample shall be taken in case analysis is required prior to re-use of reclaimed refrigerant. It is essential that electrical power is available before the task is commenced.

- a) Become familiar with the equipment and its operation.
- b) Isolate system electrically.
- c) Before attempting the procedure ensure that:
  - .Mechanical handling equipment is available, if required, for handling refrigerant cylinders;
  - .All personal protective equipment is available and being used correctly;
  - .The recovery process is supervised at all times by a competent person;
  - .Recovery equipment and cylinders conform to the appropriate standards.
- d) Pump down refrigerant system, if possible.
- e) If a vacuum is not possible, make a manifold so that refrigerant can be removed from various parts of the system.
- f) Make sure that cylinder is situated on the scales before recovery takes place.
- g) Start the recovery machine and operate in accordance with manufacturer's instructions.
- h) Do not overfill cylinders. (No more than 80% volume liquid charge).
- I) Do not exceed the maximum working pressure of the cylinder, even temporarily.
- j) When the cylinders have been filled correctly and the process completed, make sure that the cylinders and the equipment are removed from site promptly and all isolation valves on the equipment are closed off.
- k) Recovered refrigerant shall not be charged into another refrigeration system unless it has been cleaned and checked.

## 15. Labelling

Equipment shall be labelled stating that it has been de-commissioned and emptied of refrigerant. The label shall be dated and signed. Ensure that there are labels on the equipment stating the equipment contains flammable refrigerant.

## 16. Recovery

When removing refrigerant from a system, either for servicing or decommissioning, it is recommended good practice that all refrigerants are removed safely.

When transferring refrigerant into cylinders, ensure that only appropriate refrigerant recovery cylinders are employed. Ensure that the correct number of cylinders for holding



# 1. Before use

---

the total system charge is available. All cylinders to be used are designated for the recovered refrigerant and labelled for that refrigerant (i.e. special cylinders for the recovery of refrigerant). Cylinders shall be complete with pressure relief valve and associated shut-off valves in good working order. Empty recovery cylinders are evacuated and, if possible, cooled before recovery occurs. The recovery equipment shall be in good working order with a set of instructions concerning the equipment that is at hand and shall be suitable for the recovery of flammable refrigerants. In addition, a set of calibrated weighing scales shall be available and in good working order. Hoses shall be complete with leak-free disconnect couplings and in good condition. Before using the recovery machine, check that it is in satisfactory working order, has been properly maintained and that any associated electrical components are sealed to prevent ignition in the event of a refrigerant release.

Consult manufacturer if in doubt.

The recovered refrigerant shall be returned to the refrigerant supplier in the correct recovery cylinder, and the relevant Waste Transfer Note arranged. Do not mix refrigerants in recovery units and especially not in cylinders.

If compressors or compressor oils are to be removed, ensure that they have been evacuated to an acceptable level to make certain that flammable refrigerant does not remain within the lubricant. The evacuation process shall be carried out prior to returning the compressor to the suppliers. Only electric heating to the compressor body shall be employed to accelerate this process. When oil is drained from a system, it shall be carried out safely.

The unit contains fluorinated greenhouse gases. The refrigerant must not be released into the air!

All products comply with the following EU regulations:

Low Voltage Directive, Electromagnetic Compatibility.

# 1. Before use

## 1.2 Safety precautions

The following symbols are very important. Please be sure to understand their meaning, which concerns the product and your personal safety.



Warning



Caution



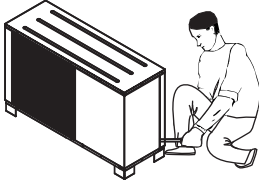

Prohibition

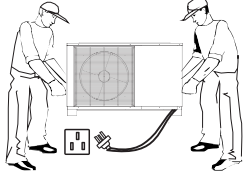

The installation, dismantlement and maintenance of the unit must be performed by qualified personnel. It is forbidden to do any changes to the structure of the unit. Otherwise injury of person or unit damage might happen.



To avoid electrical shock, make sure to disconnect the power supply 1 minute or more before servicing the electrical parts. Even after 1 minute, always measure the voltage at the terminals of main circuit capacitors or electrical parts and, before touching, make sure that those voltages are lower than the safety voltage.



Be sure to read this manual before use.

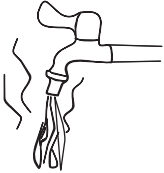

For sanitary hot water, please always add a mixture valve before water tap and set it to proper temperature.

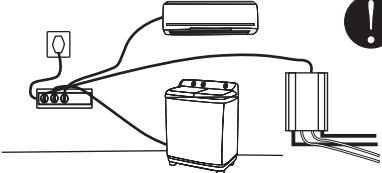

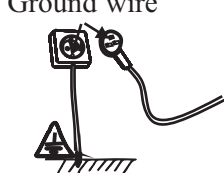

Use a dedicated socket for this unit, otherwise malfunction may occur.



Ground wire



The power supply to the unit must be grounded.



This appliance can be used by children aged from 8 years and above and persons with reduced physical, sensory or mental capabilities or lack of experience and knowledge if they have been given supervision or instruction concerning use of the appliance in a safe way and understand the hazards involved. Children shall not play with the appliance. Cleaning and user maintenance shall not be made by children without supervision.

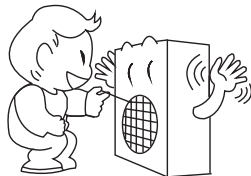

Do not touch the air outlet grill when fan motor is running.

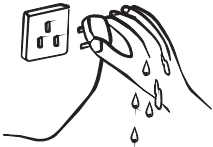

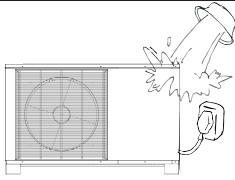

Do not touch the power plug with wet hands. Never pull out the plug by pulling the power cable.

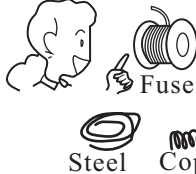
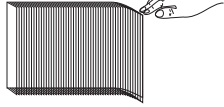

Do not operate your air conditioner in a wet room such as a bathroom or laundry room. Water or any kind of liquid is strictly forbidden to be poured into the product, or may cause electric creepage or breakdown of the product.

# 1. Before use

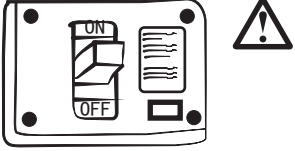
|   |  |   |
|---|--|---|
|  <p>If the supply cord is damaged, it must be replaced by the manufacturer, its service agent or similarly qualified persons in order to avoid a hazard.</p> |  <p>Please select the correct fuse or breaker as per recommended. Steel wire or copper wire cannot be taken as substitute for fuse or breaker. Otherwise, damages maybe caused.</p> |  <p>Be aware fingers might be hurt by the fin of the coil.</p> |
|---|--|---|

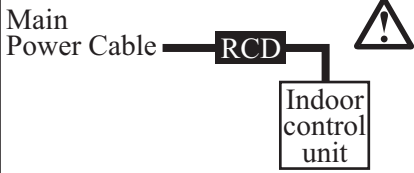
|   |  |   |
|---|--|---|
|  <p>It is mandatory to use a suitable circuit breaker for the heat pump and make sure the power supply to the unit corresponds to the specifications. Otherwise the unit might be damaged.</p> |  <p>Disposal of Scrap Batteries (if there is). Please discard the batteries as sorted municipal waste at the accessible collection point.</p> |  <p>An all-pole disconnection device which has at least 3mm clearances in all poles , and have a leakage current that may exceed 10mA, the residual current device (RCD) having a rated residual operating current not exceeding 30mA, and disconnection must be incorporated in the fixed wiring in accordance with the wiring rules.</p> |
|---|--|---|

**System water filling**

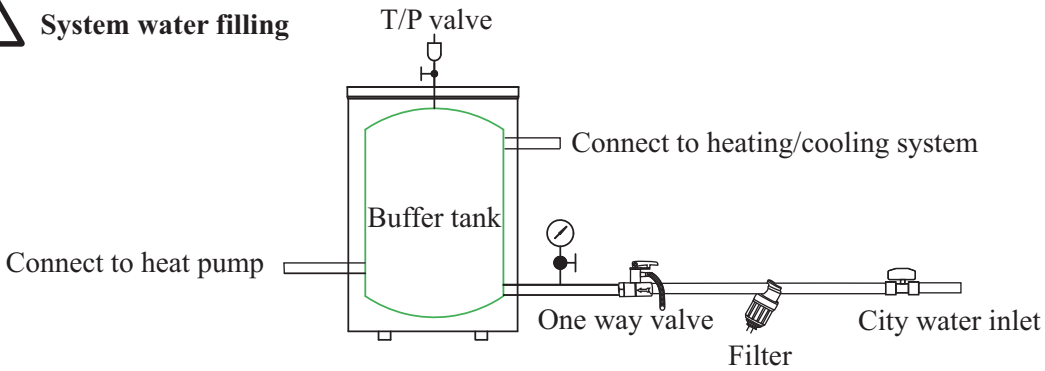

1. It's suggested to use pure water for filling the system.  
 2. If use city water for filling, please soften the water and add a filter.  
 Note: After filling, the system of water system should be 0.15~0.6MPa.

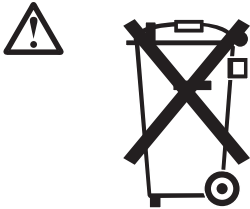
|   |   |
|---|---|
|  | <p>This marking indicates that this product should not be disposed with other household wastes throughout the EU. To prevent possible harm to the environment or human health from uncontrolled waste disposal, recycle it responsibly to promote the sustainable reuse of material resources. To return your used device, please use the return and collection systems or contact the retailer where the product was purchased. They can take this product for environmental safe recycling.</p> |
|---|---|

# 1. Before use

## 1.3 Working principle

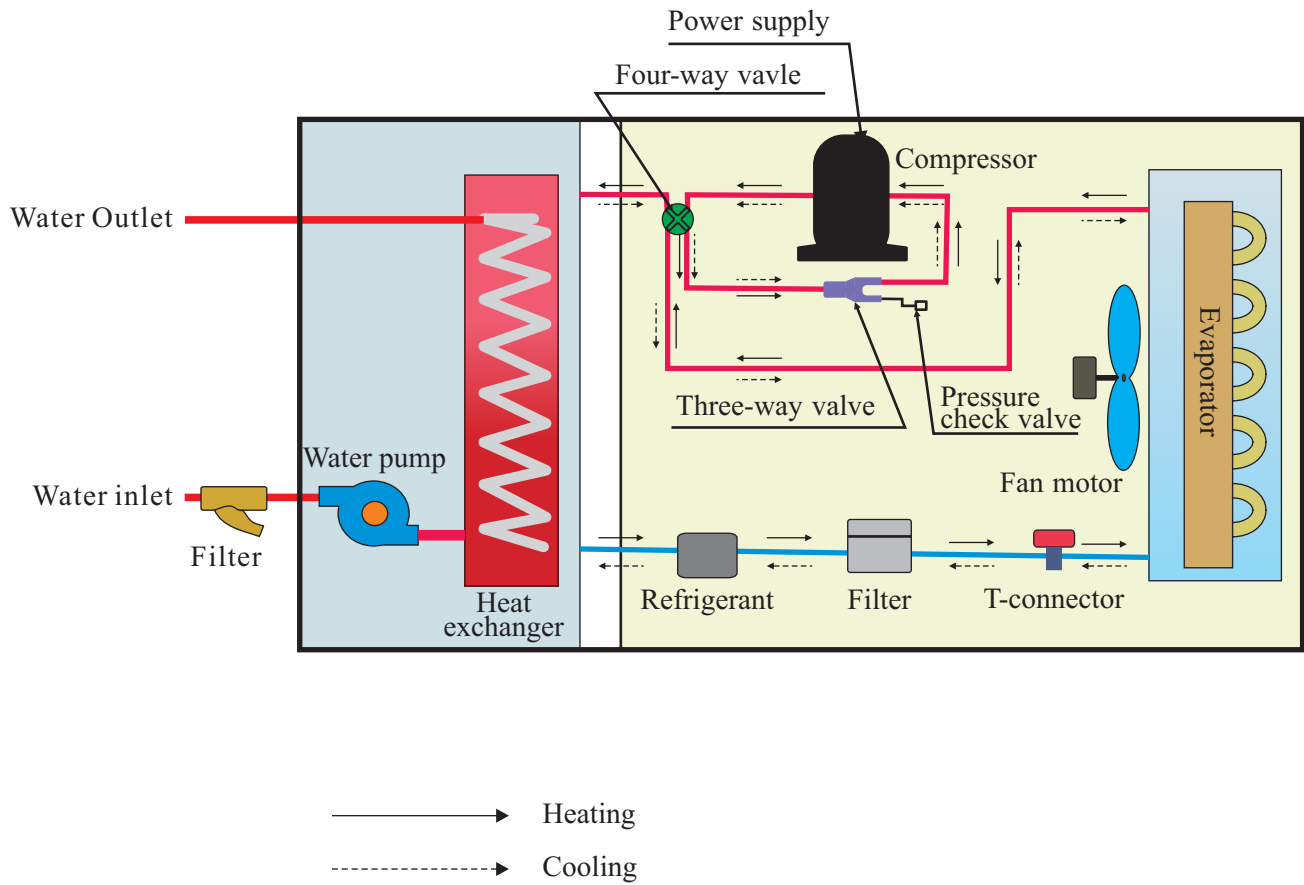

# 1. Before use

## 1.4 Main components

### 1.4.1 Indoor control unit

Thermal 6/9/12

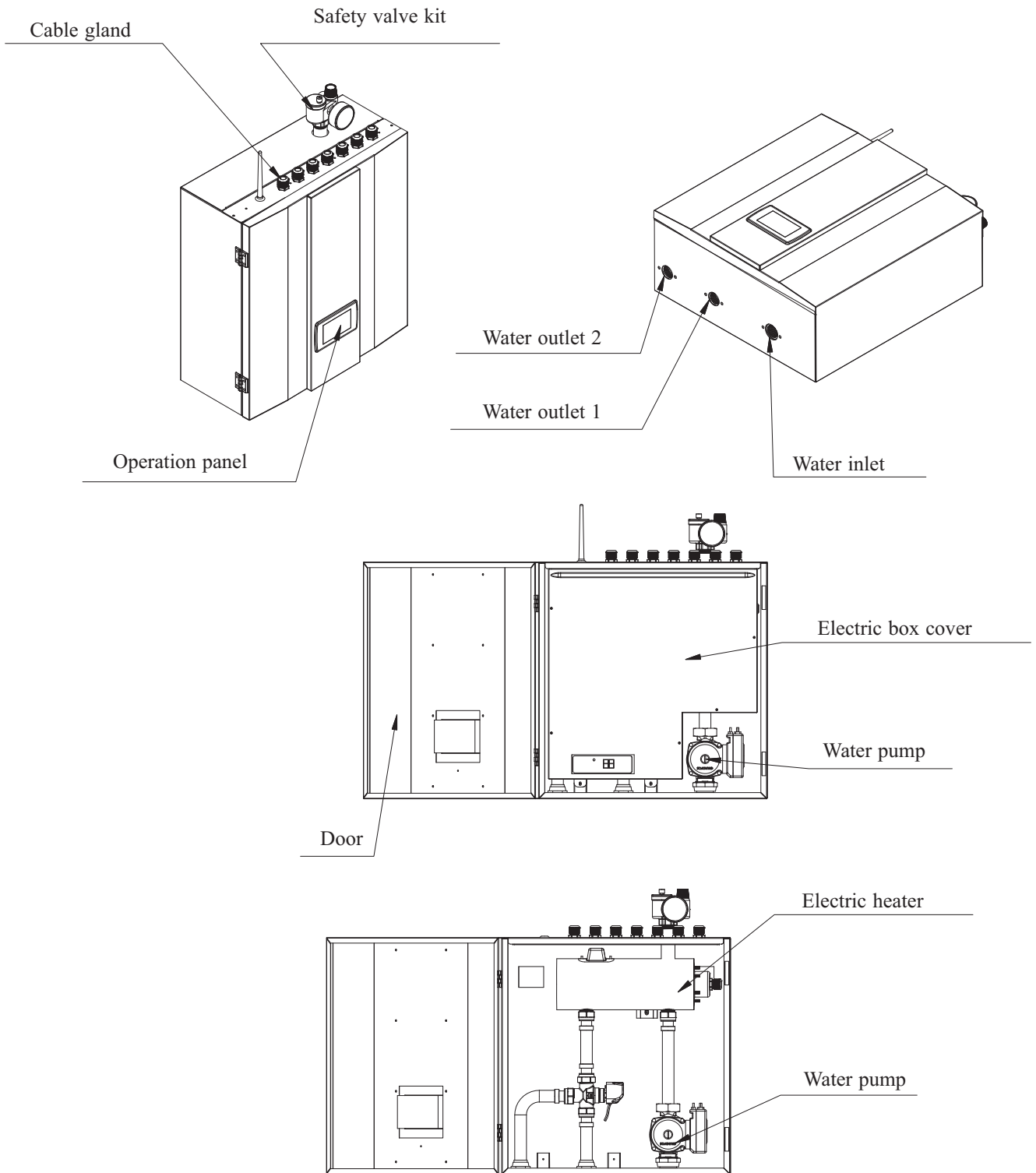

# 1. Before use

## 1.4.2 Monoblock unit

Thermal 6/9/12

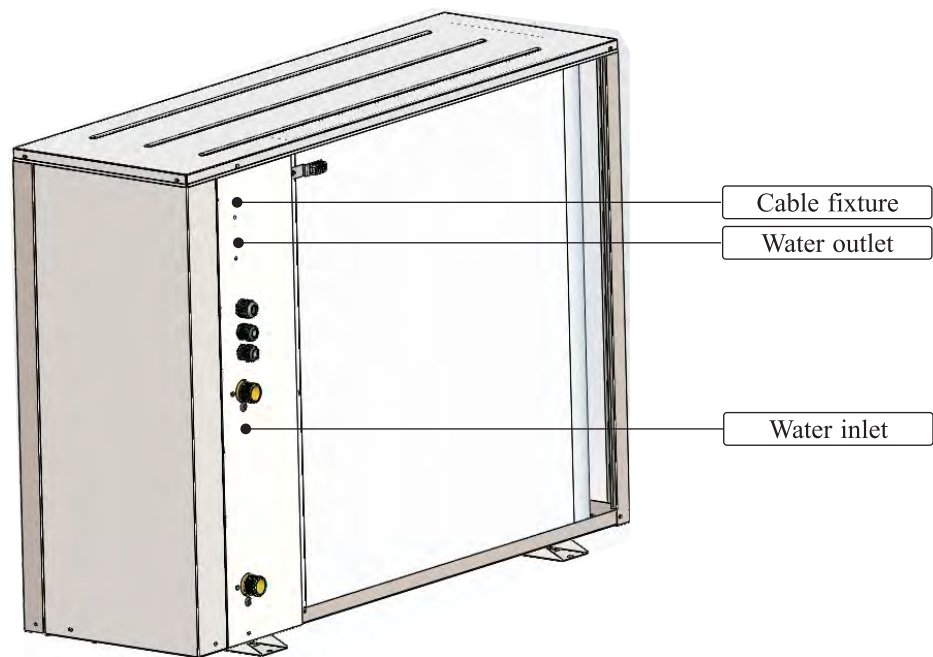
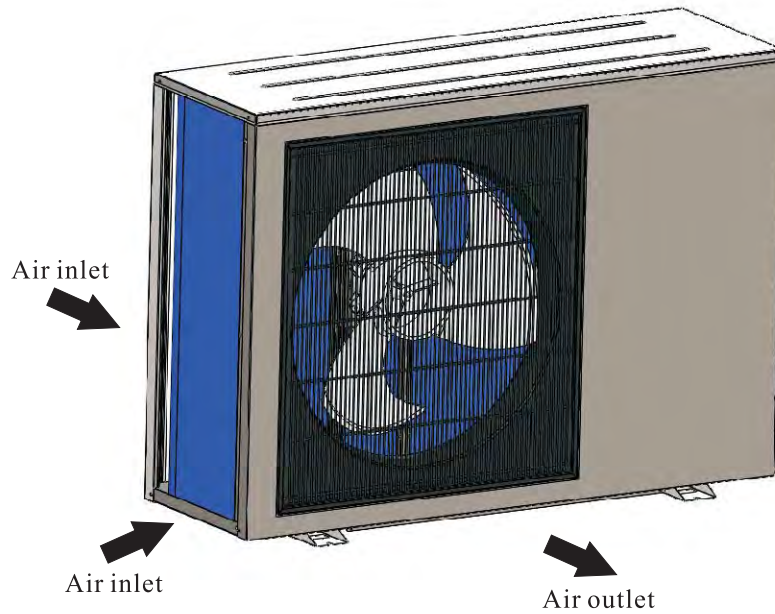

Thermal 6

GWP: 675: 0,61 tonnes equivalent CO<sub>2</sub>, refrigerant/quantity: R32/0,9kg

Thermal 9

GWP: 675: 0,95 tonnes equivalent CO<sub>2</sub>, refrigerant/quantity: R32/1,4kg.

Thermal 12

GWP: 675: 1,22 tonnes equivalent CO<sub>2</sub>, refrigerant/quantity: R32/1,8kg.

# 1. Before use

## 1.5 Specifications

| Model   |                        | Thermal 6   | Thermal 9            | Thermal 12           |                      |
|---|------------------------|---|----------------------|----------------------|----------------------|
| Power Supply / Refrigerant                              | V/Hz/Ph                | 220-240/50/1 - R32                                  |                      |                      |                      |
| Max. Heating Capacity (1)                               | kW                     | 6.5   | 9.2                  | 11.6                 |                      |
| C.O.P (1)   | W/W                    | 4.61  | 4.38                 | 4.3                  |                      |
| Heating Capacity Min./Max.(1)                           | kW                     | 3.5 / 6.5   | 4.3/9.2              | 5.5 / 11.6           |                      |
| Heating Power Input Min./Max.(1)                        | W                      | 758 / 1410  | 927/2097             | 1107 / 2683          |                      |
| C.O.P Min./Max.(1)                                      | W/W                    | 4.5 / 4.7   | 4.38/4.71            | 4.3 / 4.9            |                      |
| Max. Heating Capacity(2)                                | kW                     | 6   | 8.6                  | 11.2                 |                      |
| C.O.P (2)   | W/W                    | 3.46  | 3.37                 | 3.45                 |                      |
| Heating Capacity Min./Max.(2)                           | kW                     | 3.15 / 6  | 3.9/8.6              | 4.9 / 11.2           |                      |
| Heating power input Min./Max.(2)                        | W                      | 943 / 1732  | 1162/2550            | 1401 / 3263          |                      |
| C.O.P Min./Max.(2)                                      | W/W                    | 3.34 / 3.56   | 3.37/3.58            | 3.3 / 3.5            |                      |
| Max. Cooling Capacity (3)                               | kW                     | 7.45  | 9.5                  | 9.8                  |                      |
| E.E.R (3)   | W/W                    | 4.05  | 4.23                 | 3.9                  |                      |
| Cooling Capacity Min./Max.(3)                           | kW                     | 6.22/7.45   | 6.7/9.5              | 7.0/ 9.8             |                      |
| Cooling Power Input Min./Max.(3)                        | W                      | 1400/1863   | 1679/2242            | 1728/ 2510           |                      |
| E.E.R Min./Max.(3)                                      | W/W                    | 4.05/4.45   | 4.0/4.6              | 4.05 / 3.8           |                      |
| Max. Cooling Capacity (4)                               | kW                     | 4.5   | 7.2                  | 6.5                  |                      |
| E.E.R (4)   | W/W                    | 2.7   | 2.8                  | 2.7                  |                      |
| Cooling Capacity Min./Max.(4)                           | kW                     | 3.5/4.5   | 4.9/7.2              | 4.9 / 6.5            |                      |
| Cooling Power Input Min./Max.(4)                        | W                      | 1330/1680   | 1451/2366            | 1358 / 2444          |                      |
| E.E.R Min./Max.(4)                                      | W/W                    | 2.5/2.74  | 2.8/3.1              | 2.6 / 3.5            |                      |
| Workable Ambient Temperature Range                      | °C                     | -25~43  |                      |                      |                      |
| Min. System Water Temperature (Heating / Cooling)       | °C                     | 20 / 7  |                      |                      |                      |
| Fuse of Circuit Board (Indoor / Outdoor PCB)            |                        | Indoor: 65TS/T15AL/250V<br>Outdoor: 65TS/T25AL/250V |                      |                      |                      |
| Min. Floor Area for installation, operation and storage | m <sup>2</sup>         | 7   | 17                   | 28                   |                      |
| Min. Area of Pipe-work                                  | m <sup>2</sup>         | 7   | 17                   | 28                   |                      |
| Max. Operation High Pressure                            | MPa                    | 4.2   |                      |                      |                      |
| Max. Operation Low Pressure                             | MPa                    | 1.2   |                      |                      |                      |
| Refrigerant   | Type / Amount          | -/kg  | R32/0.9kg            | R32/1.4kg            | R32/1.8kg            |
| Compressor  | Type - Quantity/System |   | Twin Rotary - 1      | Twin Rotary - 1      | Twin Rotary - 1      |
| Fan   | Quantity               |   | 1                    | 1                    | 1                    |
|   | Airflow                | m <sup>3</sup> /h                                   | 2500                 | 3150                 | 3150                 |
|   | Rated power            | W   | 34                   | 45                   | 45                   |
| Noise Level   | Indoor/Outdoor         | dB(A)   | 44/52                | 44/52                | 44/52                |
| Water Side Heat Exchanger                               | Type                   |   | Plate Heat Exchanger | Plate Heat Exchanger | Plate Heat Exchanger |
|   | Water Pressure Drop    | kPa   | 26                   | 26                   | 26                   |
|   | Piping Connection      | Inch  | G1"                  | G1"                  | G1"                  |
| Allowable Water Flow                                    | Min./Rated./Max.       | L/S   | 0.21/0.29/0.35       | 0.26/0.43/0.52       | 0.34/0.57/0.68       |
| Net Dimension(L×D×H)                                    | Indoor Unit            | mm  | 570x550x260          | 570x550x260          | 570x550x260          |
|   | Outdoor Unit           | mm  | 1010x370x700         | 1165x370x845         | 1165x370x845         |
| Net Weight  | Indoor Unit            | Kg  | 25                   | 25                   | 25                   |
|   | Outdoor Unit           | Kg  | 65                   | 78                   | 85                   |

Note: (1) Heating condition: water inlet/outlet temperature: 30°C/35°C, Ambient temperature: DB 7°C/WB 6°C;  
(2) Heating condition: water inlet/outlet temperature: 40°C/45°C, Ambient temperature: DB 7°C/WB 6°C;  
(3) Cooling condition: water inlet/outlet temperature: 23°C/18°C, Ambient temperature: DB 35°C/WB 24°C;  
(4) Cooling condition: water inlet/outlet temperature: 12°C/7°C, Ambient temperature: DB 35°C/WB 24°C;  
(5) The specifications are subject to change without prior notice. For actual specifications of unit, please refer to the stickers on the unit.

# Locate the Configuration that Meets Your Needs

## 2. Assembly Configurations - Flowchart

Follow the flowchart on the right in order to locate which of the assembly configuration matches the needs of the end user, each of which contains specific assembly and wiring diagrams, with software instructions.

Beginning from the green “Start Here” bubble, follow the appropriate arrows to each question, which are dependent on the needs of the user.

The corresponding assembly instructions will be found by turning to the page number in the end bubble.

**Note:** *The instructions in this section are meant to achieve the minimum requirements for successful system operation only.*

*For more in-depth settings explanations, please refer to the user’s manual.*

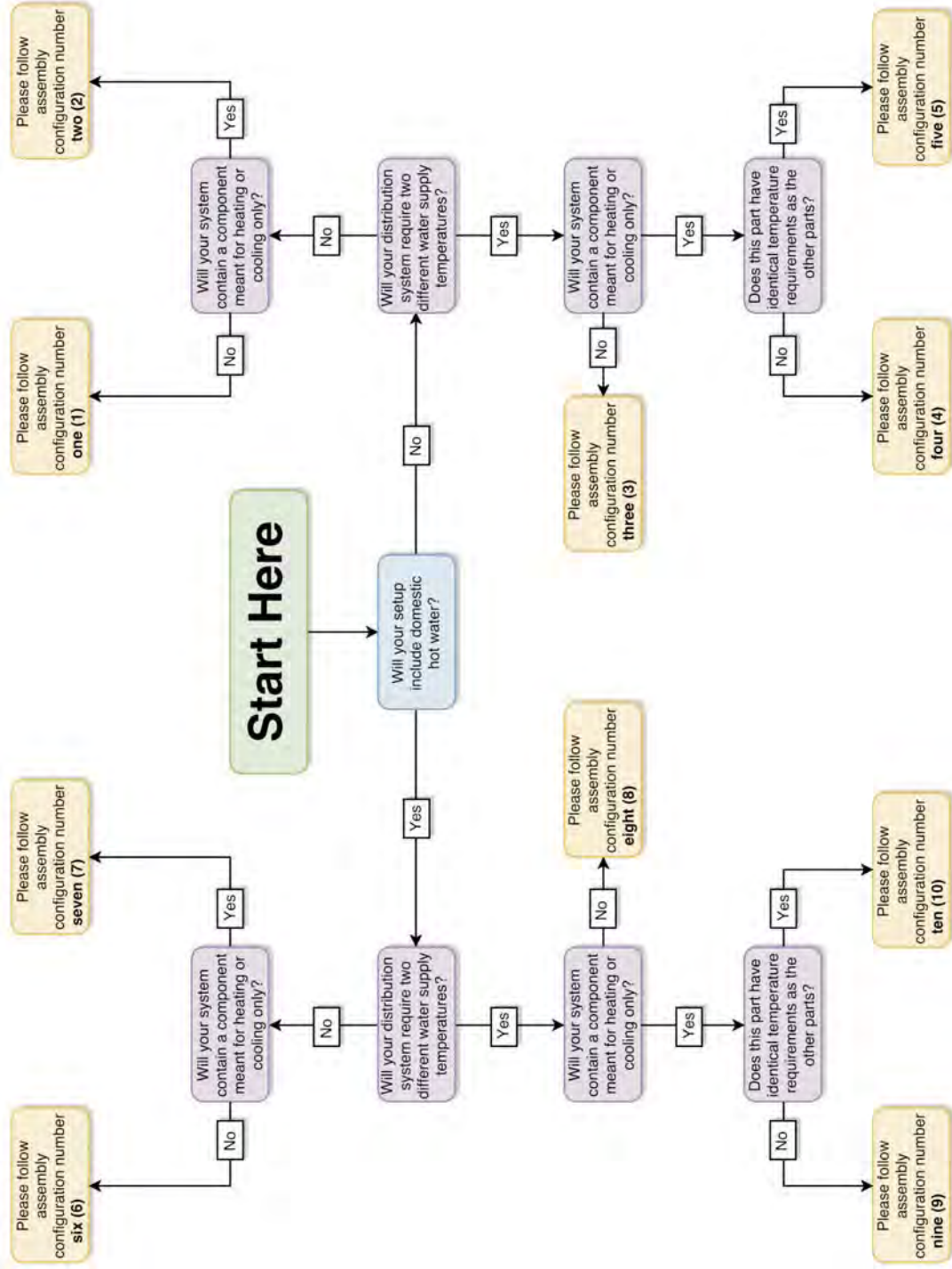



## 2. Assembly Configurations – Drawing 1

Please ensure that the configuration matches the assembly drawing depicted on the right for a one temperature zone without domestic hot water setup.

*Note: Refer to the next page for wiring and software operation instructions.*

| Name              | Symbol | Name            | Symbol |
|-------------------|--------|-----------------|--------|
| Temp. Sensor      |        | Water pump      |        |
| Safety valve Kit  |        | Mixing valve    |        |
| Ball valve        |        | Motorized valve |        |
| Water filter      |        | Expansion tank  |        |
| Air purging valve |        |                 |        |

*Note: Dotted lines mean "able to be controlled by the Heat Pump".*

*Notice: The Fan Coil Unit, Floor Heating System, and Radiator are placeholder distribution systems only and can be substituted by any other appropriate distribution systems.*

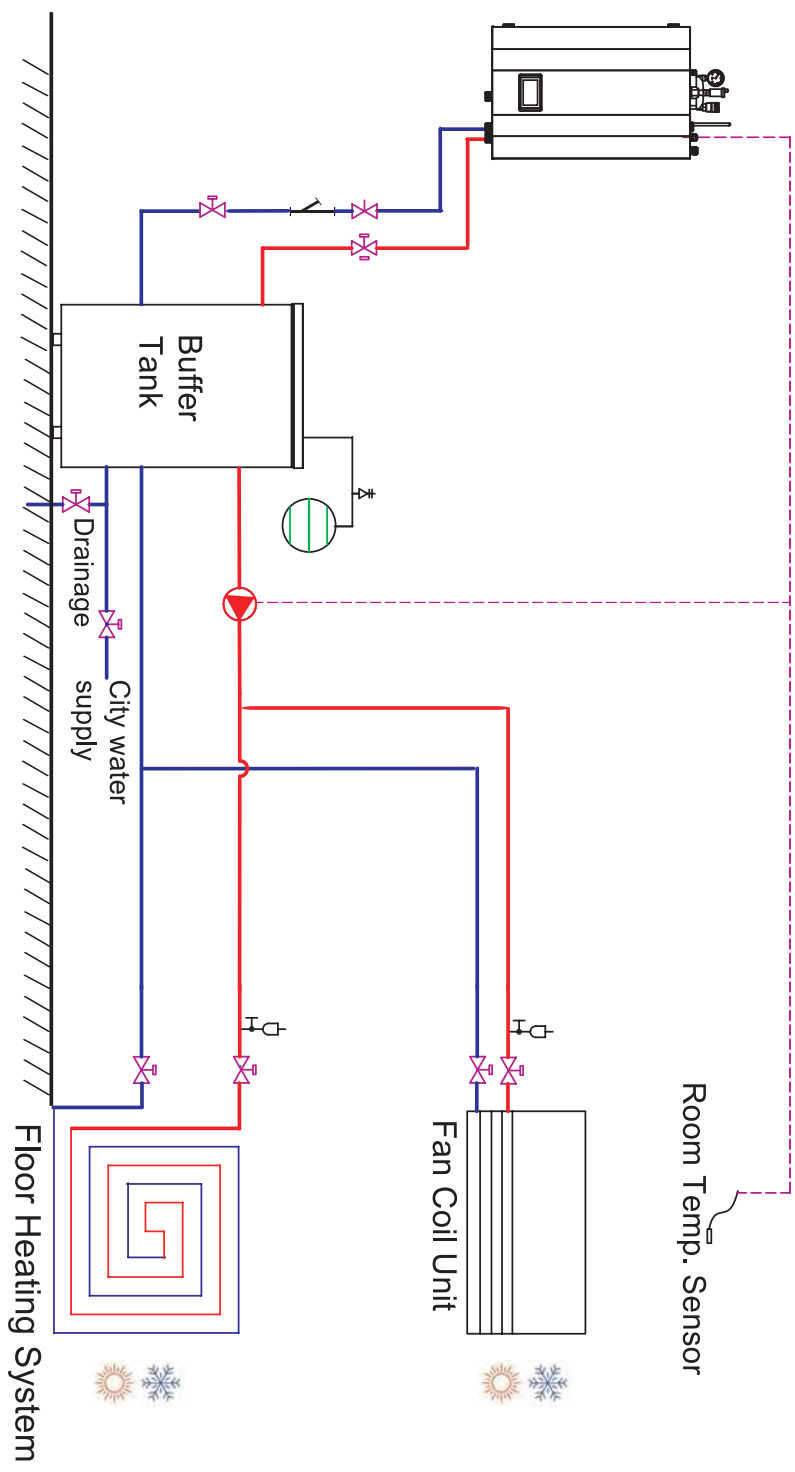

One Temperature Zone, without DHW

# 2. Assembly Configurations – Drawing 1

## Assembly 1: Wiring Diagram

To achieve successful operation at a minimum, ensure the ports below are properly connected.

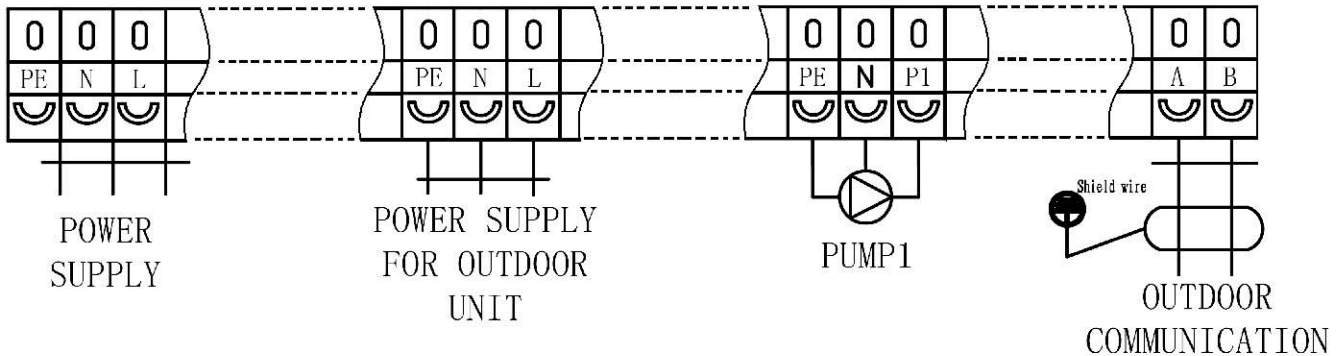

## Software: Basic Settings

1. Set the needed working modes of the unit via the menu

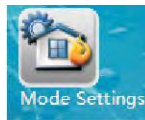

2. Temperature configuration options for Heating/Cooling circuit 1 are found under



**H.** Configuring the set water heating temperatures:

**H.1.** Setting a heating curve:



|                 |       |
|-----------------|-------|
| Ambient Temp. 1 | -25°C |
| Ambient Temp. 2 | -15°C |
| Ambient Temp. 3 | -5°C  |
| Ambient Temp. 4 | 5°C   |
| Ambient Temp. 5 | 10°C  |

|                               |      |
|-------------------------------|------|
| Water Temp. A/Ambient Temp. 1 | 40°C |
| Water Temp. B/Ambient Temp. 2 | 37°C |
| Water Temp. C/Ambient Temp. 3 | 33°C |
| Water Temp. D/Ambient Temp. 4 | 29°C |
| Water Temp. E/Ambient Temp. 5 | 25°C |

**H.2.** If no heating curve is desired:

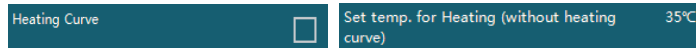

**C.** Configuring the set water cooling temperature (if applicable):

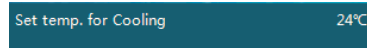

If cooling function is desired, ensure these sections are configured.

3. Locate and activate the buffer tank and appropriate pumps under

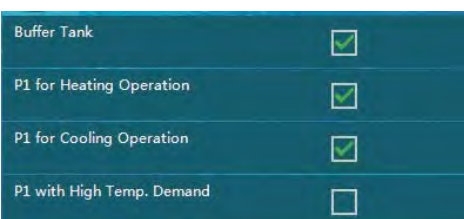

## 2. Assembly Configurations – Drawing 2

Please ensure that the configuration matches the assembly drawing depicted on the right for a one temperature zone without domestic hot water setup, that includes a component circuit capable of heating or cooling only, through the use of a two-way motorized valve.

**Note:** For the cooling-only or heating-only circuit, a motorized two-way valve can be connected to the unit, to cut the water supply during heating or cooling operation.  
Refer to the next page for wiring and software operation instructions.

| Name              | Symbol | Name            | Symbol |
|-------------------|--------|-----------------|--------|
| Temp. Sensor      |        | Water pump      |        |
| Safety valve kit  |        | Mixing valve    |        |
| Ball valve        |        | Motorized valve |        |
| Water filter      |        | Expansion tank  |        |
| Air purging valve |        |                 |        |

**Note:** Dotted lines mean "able to be controlled by the Heat Pump".

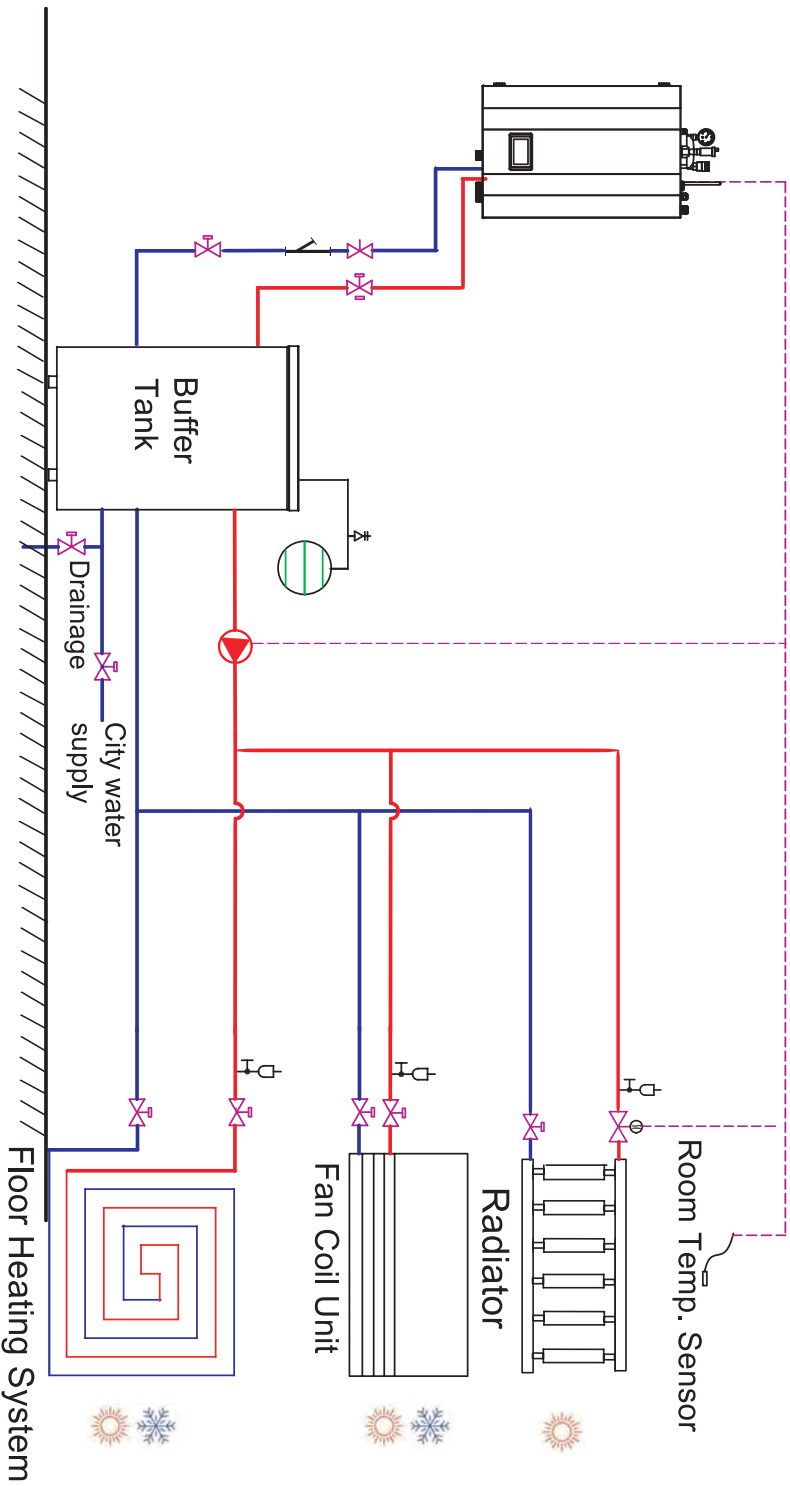

**Notice:** The Fan Coil Unit, Floor Heating System, and Radiator are placeholder distribution systems only and can be substituted by any other appropriate distribution systems.

One Temperature Zone, without DHW, with a heating-only (or cooling-only) circuit, by usage of a motorized 2-way valve

## 2. Assembly Configurations – Drawing 2

### Assembly 2: Wiring Diagram

To achieve successful operation at a minimum, ensure the ports below are properly connected.

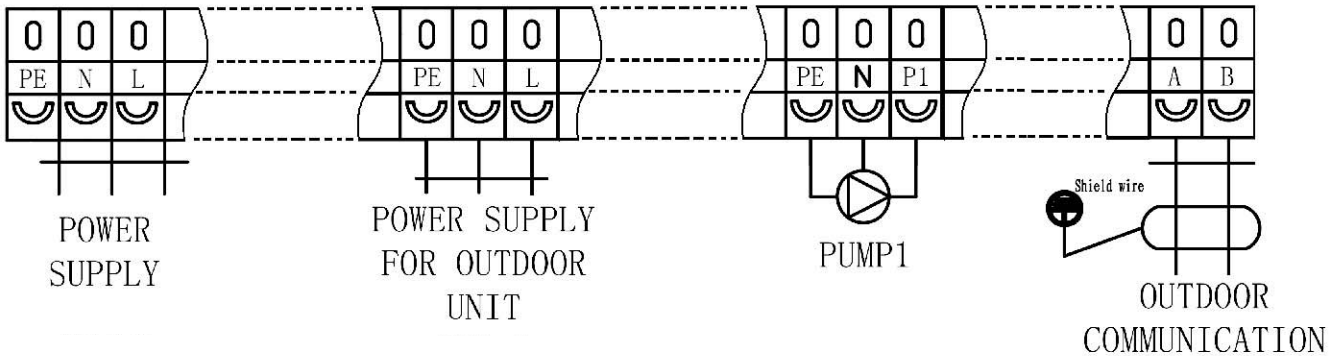

### Software: Basic Settings

1. Set the needed working modes of the unit via the menu



2. Temperature configuration options for Heating/Cooling circuit 1 are found under



**H.**Configuring the set water heating temperatures:

**H.1.**Setting a heating curve:



|                 |       |
|-----------------|-------|
| Ambient Temp. 1 | 25°C  |
| Ambient Temp. 2 | -15°C |
| Ambient Temp. 3 | -5°C  |
| Ambient Temp. 4 | 5°C   |
| Ambient Temp. 5 | 10°C  |

|                               |      |
|-------------------------------|------|
| Water Temp. A/Ambient Temp. 1 | 40°C |
| Water Temp. B/Ambient Temp. 2 | 37°C |
| Water Temp. C/Ambient Temp. 3 | 33°C |
| Water Temp. D/Ambient Temp. 4 | 29°C |
| Water Temp. E/Ambient Temp. 5 | 25°C |

**H.2.** If no heating curve is desired:

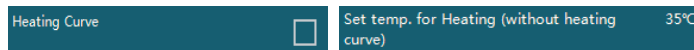

**C.**Configuring the set water cooling temperature (if applicable):



If cooling function is desired, ensure these sections are configured.

3. Locate and activate the buffer tank and appropriate pumps under



## 2. Assembly Configurations – Drawing 2

---





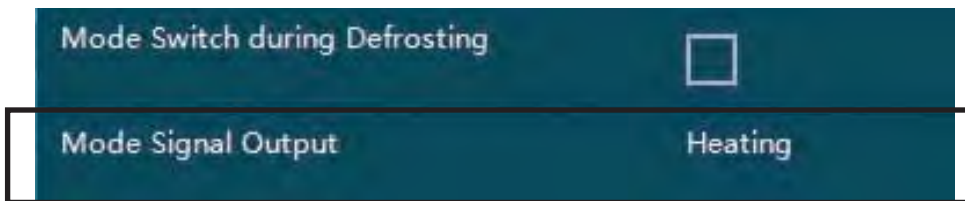
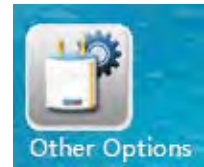



### Software: Basic Settings (continued)

4. The location of the configuration for heating-only or cooling-only system is under



## 2. Assembly Configurations – Drawing 3

*Notice: The Fan Coil Unit, Floor Heating System, and Radiator are placeholder distribution systems only and can be substituted by any other appropriate distribution systems.*

| Name              | Symbol  | Name            | Symbol  |
|-------------------|---|-----------------|---|
| Temp. Sensor      |  | Water pump      |  |
| Safety valve Kit  |  | Mixing valve    |  |
| Ball valve        |  | Motorized valve |  |
| Water filter      |  | Expansion tank  |  |
| Air purging valve |  |                 |   |

Note: Dotted lines mean "able to be controlled by the Heat Pump".

Please ensure that the configuration matches the assembly drawing depicted on the right for a two temperature zone without domestic hot water setup.

Note: Refer to the next page for wiring and software operation instructions.

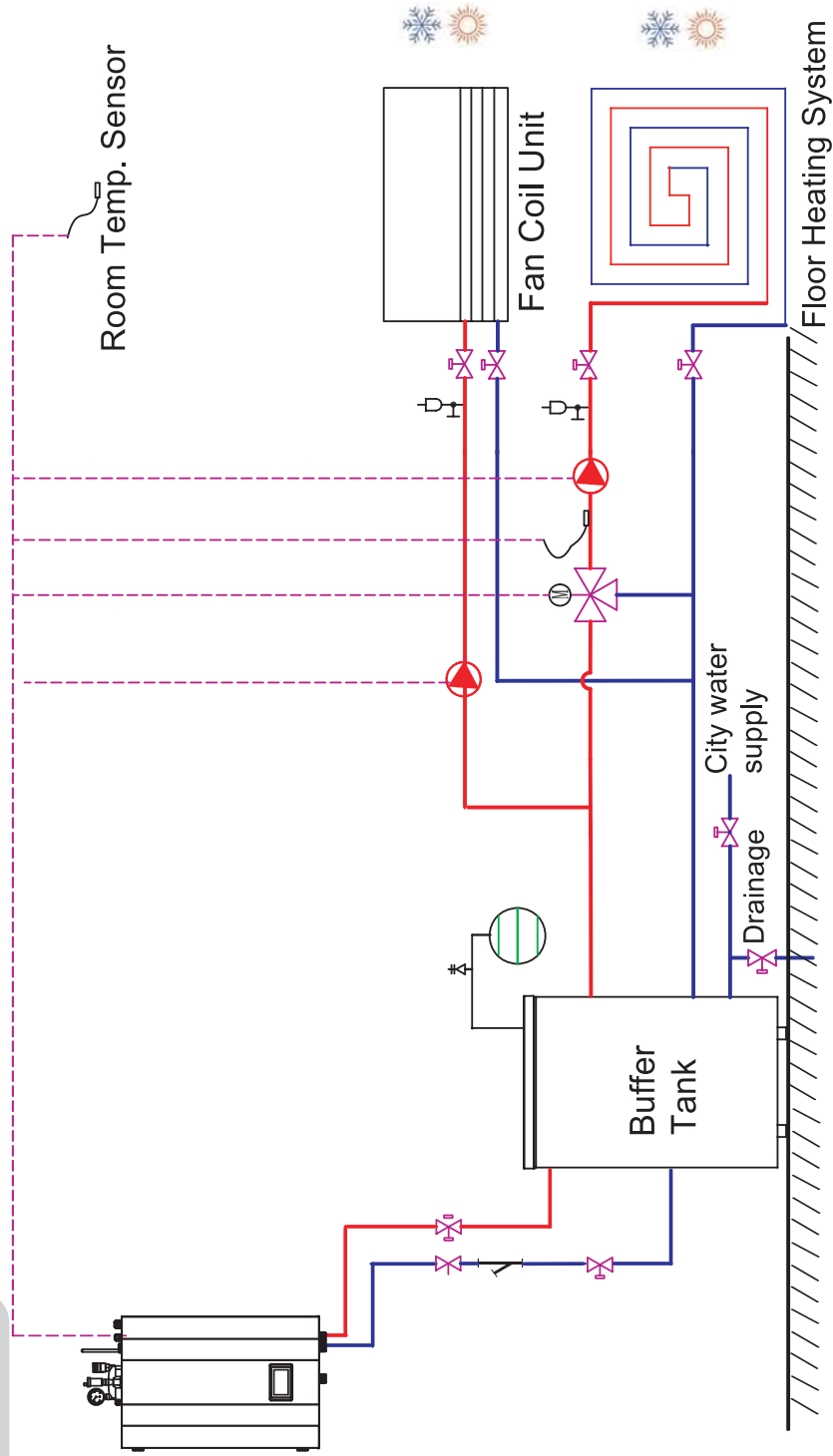

Two Temperature Zones , without DHW

## 2. Assembly Configurations – Drawing 3

### Assembly 3: Wiring Diagram

To achieve successful operation at a minimum, ensure the ports below are properly connected.

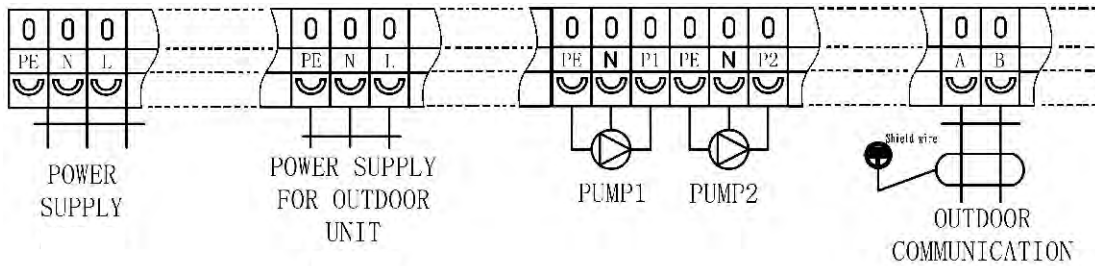

For connection for mixing valve 2, please refer to the appendix A (on page 128-129) of this manual for more information.

### Software: Basic Settings

1. Set the needed working modes of the unit via the menu



2. Temperature configuration options for Heating/Cooling circuit 1 are found under



**H.** Configuring the set water heating temperatures:

**H.1.** Setting a heating curve:



|                 |       |                               |      |
|-----------------|-------|-------------------------------|------|
| Ambient Temp. 1 | -25°C | Water Temp. A/Ambient Temp. 1 | 40°C |
| Ambient Temp. 2 | -15°C | Water Temp. B/Ambient Temp. 2 | 37°C |
| Ambient Temp. 3 | -5°C  | Water Temp. C/Ambient Temp. 3 | 33°C |
| Ambient Temp. 4 | 5°C   | Water Temp. D/Ambient Temp. 4 | 29°C |
| Ambient Temp. 5 | 10°C  | Water Temp. E/Ambient Temp. 5 | 25°C |

**H.2.** If no heating curve is desired:

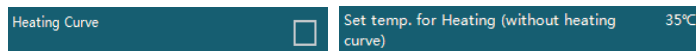

**C.** Configuring the set water cooling temperature (if applicable):

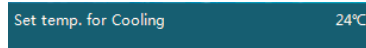

If cooling function is desired, ensure these sections are configured.

3. Locate and activate the buffer tank and appropriate pumps under



## 2. Assembly Configurations – Drawing 3

### Software: Basic Settings (continued)

3.(cont.) Configure the water pump to operate for heating or cooling:

|                          |                                     |
|--------------------------|-------------------------------------|
| P2 for Heating Operation | <input checked="" type="checkbox"/> |
| P2 for Cooling Operation | <input type="checkbox"/>            |

4. Temperature configuration options for Heating/Cooling circuit 2 are found under  
Please activate entire Heating/Cooling circuit 2 setting

|                          |                                     |
|--------------------------|-------------------------------------|
| Heatingcooling Circuit 2 | <input checked="" type="checkbox"/> |
|--------------------------|-------------------------------------|



H. Configuring the set water heating temperatures:

H.1. Setting a heating curve:

|               |                                     |
|---------------|-------------------------------------|
| Heating Curve | <input checked="" type="checkbox"/> |
|---------------|-------------------------------------|

|                               |      |
|-------------------------------|------|
| Water Temp. A/Ambient Temp. 1 | 40°C |
| Water Temp. B/Ambient Temp. 2 | 37°C |
| Water Temp. C/Ambient Temp. 3 | 33°C |
| Water Temp. D/Ambient Temp. 4 | 29°C |
| Water Temp. E/Ambient Temp. 5 | 25°C |

H.2. If no heating curve is desired:

|               |                          |
|---------------|--------------------------|
| Heating Curve | <input type="checkbox"/> |
|---------------|--------------------------|

|   |      |
|---|------|
| Set Temp. for Heating (without heating curve) | 35°C |
|---|------|

C. Configuring the set water cooling temperature (if applicable):

|                       |      |
|-----------------------|------|
| Set temp. For Cooling | 24°C |
|-----------------------|------|

4.1. Activate the mixing valve to manage the second circuit:

|              |                                     |
|--------------|-------------------------------------|
| Mixing Valve | <input checked="" type="checkbox"/> |
|--------------|-------------------------------------|

*Note: This pair of settings will interpret “Heating/Cooling Circuit 2 as the low demand distribution system, requiring a lower set temperature for heating and higher set temperature for cooling.*

Dependent on whether cooling is needed











## 2. Assembly Configurations – Drawing 4

Please ensure that the configuration matches the assembly drawing depicted on the right for a two temperature zone without domestic hot water setup, that includes a component circuit capable of heating or cooling only through the use of a two-way motorized valve.

*Note:* For the cooling-only or heating-only circuit, a motorized two-way valve can be connected to the unit, to cut the water supply during heating or cooling operation.

*Refer to the next page for wiring and software operation instructions.*

| Name              | Symbol  | Name            | Symbol  |
|-------------------|---|-----------------|---|
| Temp. Sensor      |  | Water pump      |  |
| Safety valve kit  |  | Mixing valve    |  |
| Ball valve        |  | Motorized valve |  |
| Water filter      |  | Expansion tank  |  |
| Air purging valve |  |                 |   |

*Note:* Dotted lines mean "able to be controlled by the Heat Pump".

*Notice:* The Fan Coil Unit, Floor Heating System, and Radiator are placeholder distribution systems only and can be substituted by any other appropriate distribution systems.

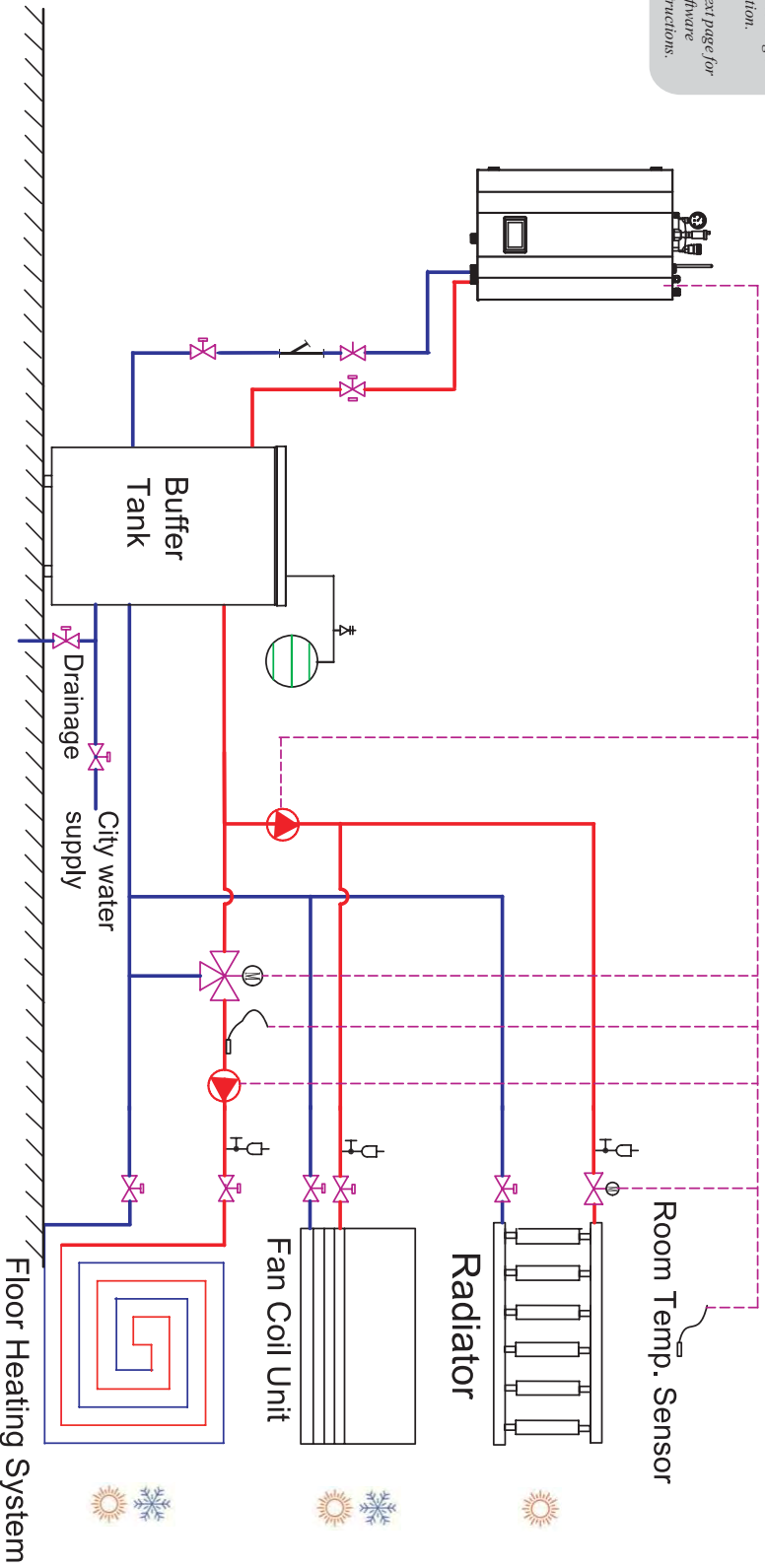

Two Temperature Zones , without DHW, with a heating-only (or cooling-only) circuit, by usage of a motorized 2-way valve

## 2. Assembly Configurations – Drawing 4

### Assembly 4: Wiring Diagram

To achieve successful operation at a minimum, ensure the ports below are properly connected.

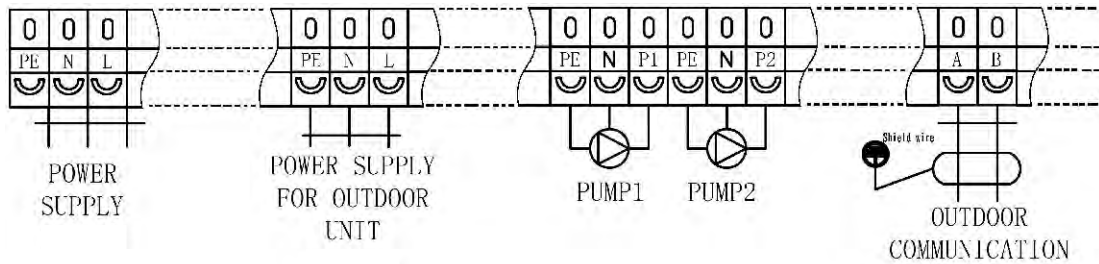

For connection for mixing valve 2, please refer to the appendix A (on page 128-129) of this manual for more information.

### Software: Basic Settings

1. Set the needed working modes of the unit via the menu

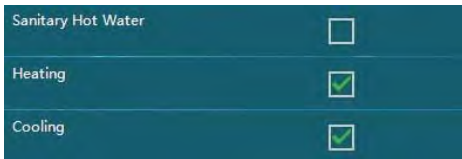

2. Temperature configuration options for Heating/Cooling circuit 1 are found under



**H.** Configuring the set water heating temperatures:

**H.1.** Setting a heating curve:



|                 |       |
|-----------------|-------|
| Ambient Temp. 1 | -25°C |
| Ambient Temp. 2 | -15°C |
| Ambient Temp. 3 | -5°C  |
| Ambient Temp. 4 | 5°C   |
| Ambient Temp. 5 | 10°C  |

|                               |      |
|-------------------------------|------|
| Water Temp. A/Ambient Temp. 1 | 40°C |
| Water Temp. B/Ambient Temp. 2 | 37°C |
| Water Temp. C/Ambient Temp. 3 | 33°C |
| Water Temp. D/Ambient Temp. 4 | 29°C |
| Water Temp. E/Ambient Temp. 5 | 25°C |

**H.2.** If no heating curve is desired:

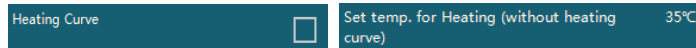

**C.** Configuring the set water cooling temperature (if applicable):

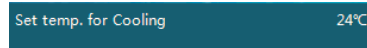

If cooling function is desired, ensure these sections are configured.

3. Locate and activate the buffer tank and appropriate pumps under

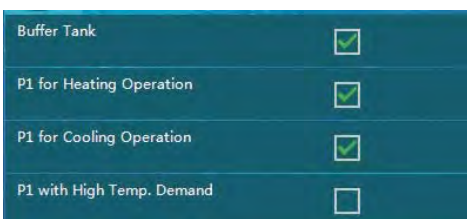

## 2. Assembly Configurations – Drawing 4

### Software: Basic Settings (continued)

3.(cont.) Configure the water pump to operate for heating or cooling:



4. The location of the configuration for heating-only or cooling-only system is under

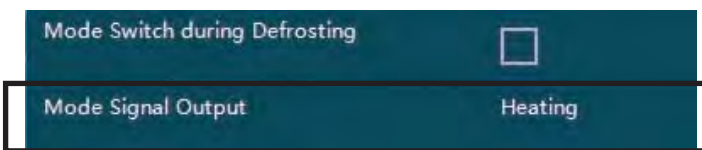
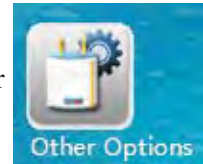

5. Temperature configuration options for Heating/Cooling circuit 2 are found under



H. Configuring the set water heating temperatures:

H.1. Setting a heating curve:



|                               |      |
|-------------------------------|------|
| Water Temp. A/Ambient Temp. 1 | 40°C |
| Water Temp. B/Ambient Temp. 2 | 37°C |
| Water Temp. C/Ambient Temp. 3 | 33°C |
| Water Temp. D/Ambient Temp. 4 | 29°C |
| Water Temp. E/Ambient Temp. 5 | 25°C |

H.2. If no heating curve is desired:

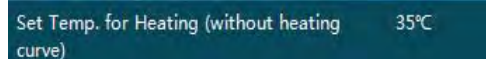

C. Configuring the set water cooling temperature (if applicable):



5.1. Activate the mixing valve to manage the second circuit:











*Note: This pair of settings will interpret "Heating/Cooling Circuit 2 as the low demand distribution system, requiring a lower set temperature for heating and higher set temperature for cooling.*

Dependent on whether cooling is needed

## 2. Assembly Configurations – Drawing 5

*Notice: The Fan Coil Unit, Floor Heating System, and Radiator are placeholder distribution systems only and can be substituted by any other appropriate distribution systems.*

| Name              | Symbol  | Name            | Symbol  |
|-------------------|---|-----------------|---|
| Temp. Sensor      |  | Water pump      |  |
| Safety valve Kit  |  | Mixing valve    |  |
| Ball valve        |  | Motorized valve |  |
| Water filter      |  | Expansion tank  |  |
| Air purging valve |  |                 |   |

Note: Dotted lines mean "able to be controlled by the Heat Pump".

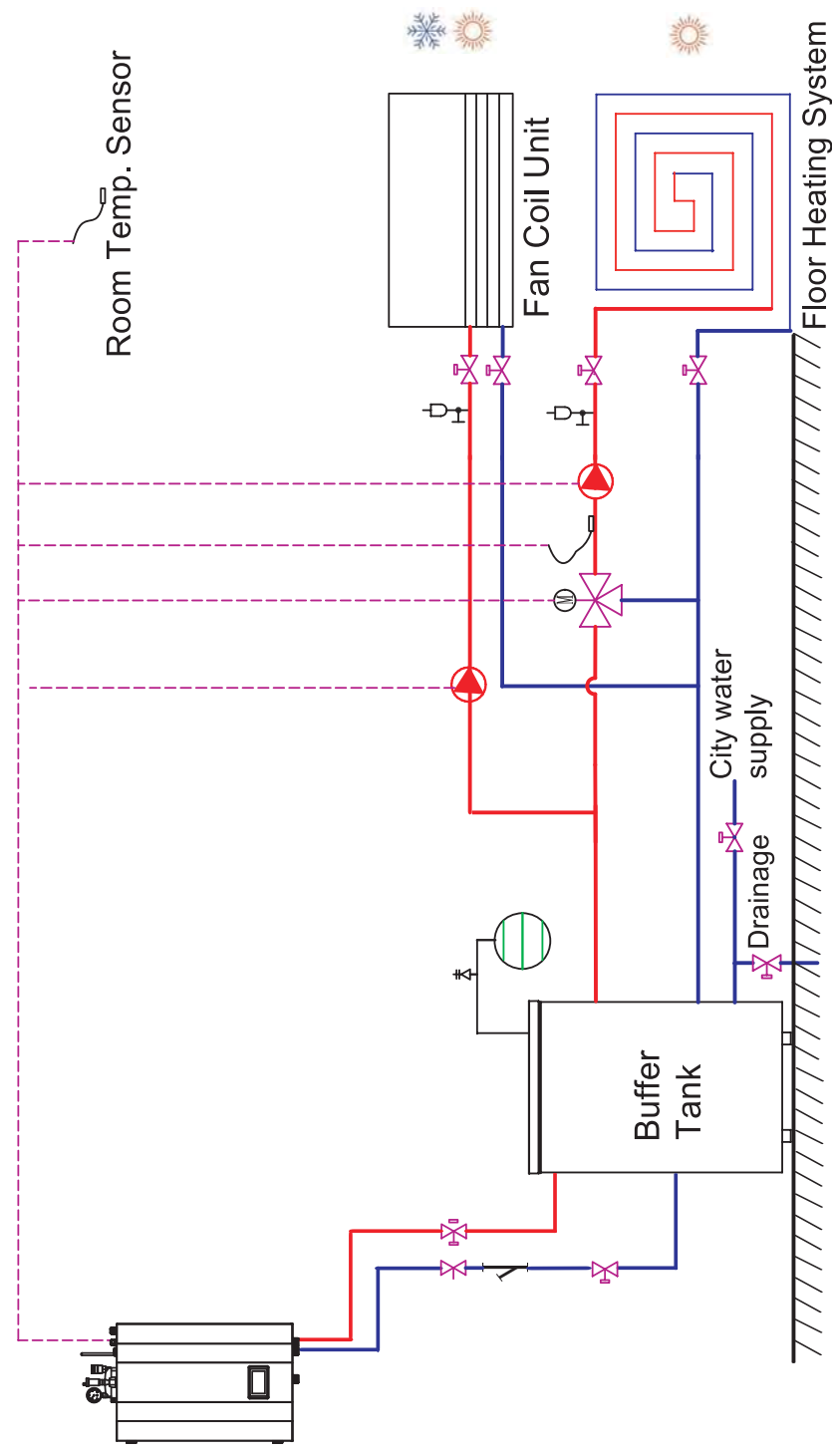

Please ensure that the configuration matches the assembly drawing depicted on the right for a two temperature zone without domestic hot water setup, that utilizes the secondary pump for a heating-only operation.

*Note: For the heating-only circuit, a motorized two-way valve can be connected to the unit, to cut the water supply during heating operation.*

*Refer to the next page for wiring and software operation instructions.*

Two Temperature Zones , without DHW, with a heating-only circuit, enabled by setting the secondary pump to heating-only

## 2. Assembly Configurations – Drawing 5

### Assembly 5: Wiring Diagram

To achieve successful operation at a minimum, ensure the ports below are properly connected.

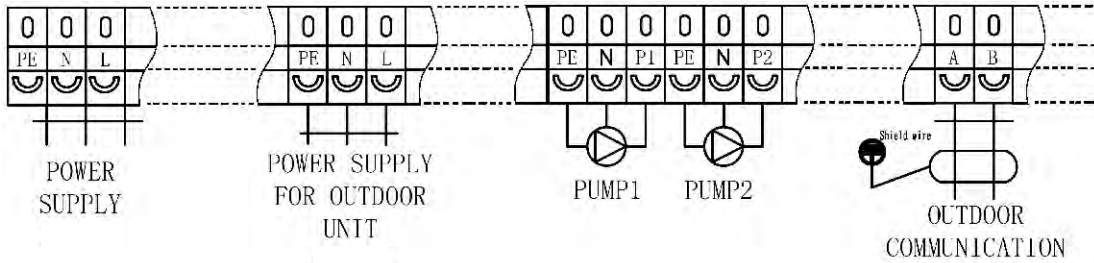

For connection for mixing valve 2, please refer to the appendix A (on page 128-129) of this manual for more information.

### Software: Basic Settings

1. Set the needed working modes of the unit via the menu

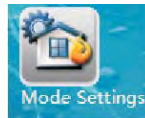

2. Temperature configuration options for Heating/Cooling circuit 1 are found under



**H.** Configuring the set water heating temperatures:

**H.1.** Setting a heating curve:



|                 |       |
|-----------------|-------|
| Ambient Temp. 1 | -25°C |
| Ambient Temp. 2 | -15°C |
| Ambient Temp. 3 | -5°C  |
| Ambient Temp. 4 | 5°C   |
| Ambient Temp. 5 | 10°C  |

|                               |      |
|-------------------------------|------|
| Water Temp. A/Ambient Temp. 1 | 40°C |
| Water Temp. B/Ambient Temp. 2 | 37°C |
| Water Temp. C/Ambient Temp. 3 | 33°C |
| Water Temp. D/Ambient Temp. 4 | 29°C |
| Water Temp. E/Ambient Temp. 5 | 25°C |

**H.2.** If no heating curve is desired:

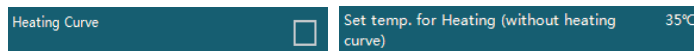

**C.** Configuring the set water cooling temperature (if applicable):

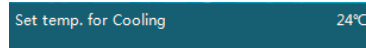

If cooling function is desired, ensure these sections are configured.

3. Locate and activate the buffer tank and appropriate pumps under



## 2. Assembly Configurations – Drawing 5

### Software: Basic Settings (continued)

3.(cont.) Configure the water pump to operate for heating or cooling:

P2 for Heating Operation



4. Temperature configuration options for Heating/Cooling circuit 2 are found under

H. Configuring the set water heating temperatures:

H.1. Setting a heating curve:

Heating Curve

|                               |      |
|-------------------------------|------|
| Water Temp. A/Ambient Temp. 1 | 40°C |
| Water Temp. B/Ambient Temp. 2 | 37°C |
| Water Temp. C/Ambient Temp. 3 | 33°C |
| Water Temp. D/Ambient Temp. 4 | 29°C |
| Water Temp. E/Ambient Temp. 5 | 25°C |

H.2. If no heating curve is desired:

Heating Curve

Set Temp. for Heating (without heating curve) 35°C

C. Configuring the set water cooling temperature (if applicable):

Set temp. For Cooling 24°C

4.1. Activate the mixing valve to manage the second circuit:

Mixing Valve

*Note: This pair of settings will interpret “Heating/Cooling Circuit 2 as the low demand distribution system, requiring a lower set temperature for heating and higher set temperature for cooling.*

## 2. Assembly Configurations – Drawing 6

Please ensure that the configuration matches the assembly drawing depicted on the right for a one temperature zone setup that includes domestic hot water.

*Note: Refer to the next page for wiring and software operation instructions.*

| Name              | Symbol | Name            | Symbol |
|-------------------|--------|-----------------|--------|
| Temp. Sensor      |        | Water pump      |        |
| Safety valve Kit  |        | Mixing valve    |        |
| Ball valve        |        | Motorized valve |        |
| Water filter      |        | Expansion tank  |        |
| Air purging valve |        |                 |        |

*Note: Dotted lines mean "able to be controlled by the Heat Pump". distribution systems.*

*Notice: The Fan Coil Unit, Floor Heating System, and Radiator are placeholder distribution systems only and can be substituted by any other appropriate*

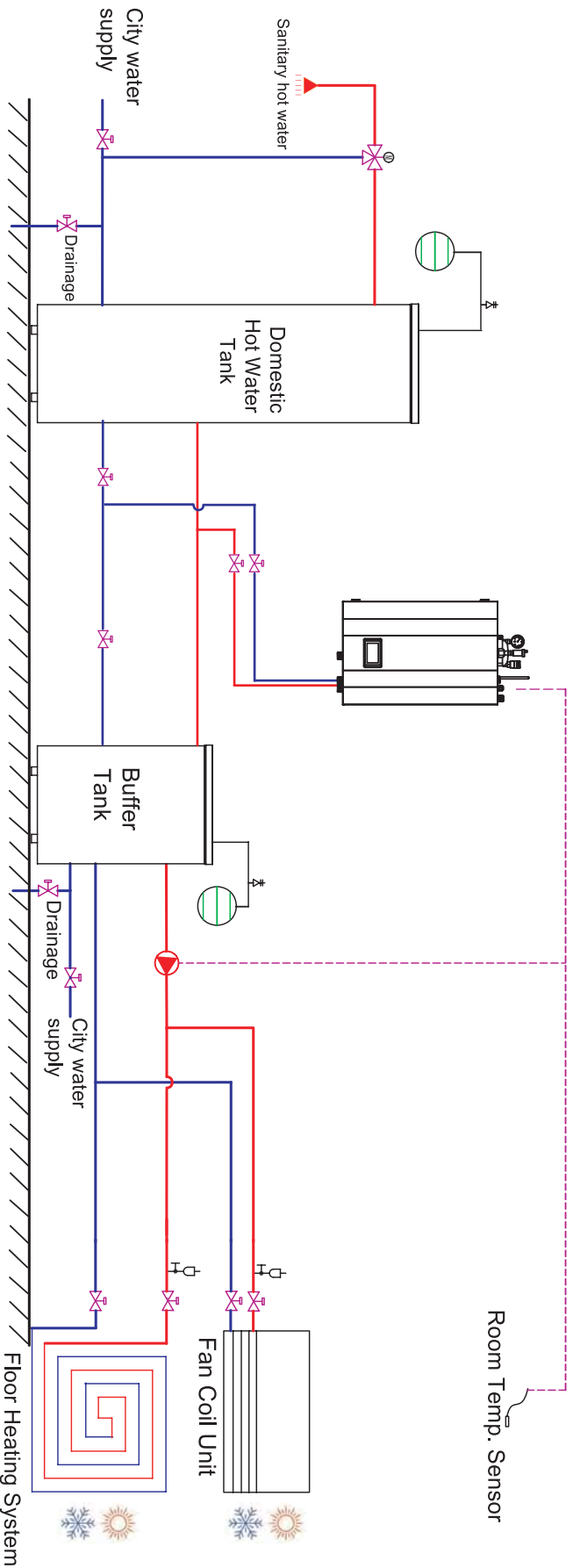

One Temperature Zone, with DHW

## 2. Assembly Configurations – Drawing 6

### Assembly 6: Wiring Diagram

To achieve successful operation at a minimum, ensure the ports below are properly connected.

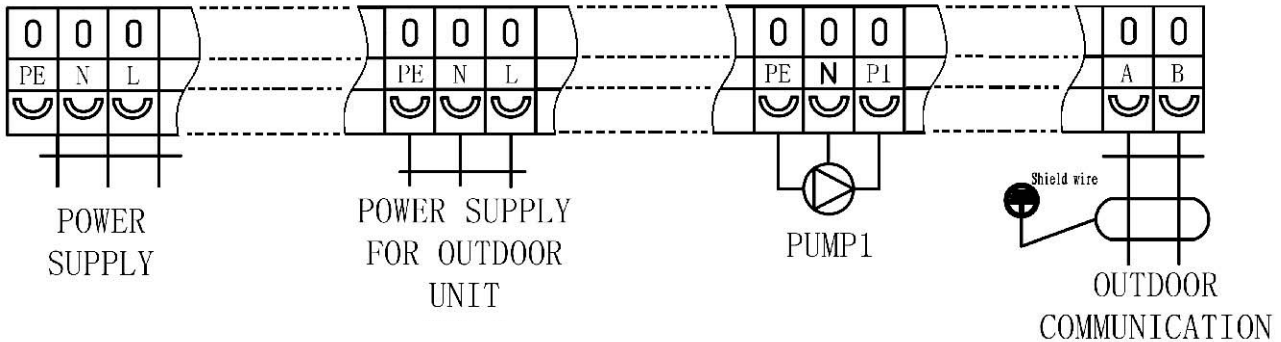

### Software: Basic Settings

1. Set the needed working modes of the unit via the menu

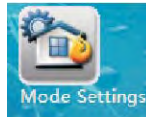

2. Temperature configuration options for Heating/Cooling circuit 1 are found under



**H.** Configuring the set water heating temperatures:

**H.1.** Setting a heating curve:



|                 |       |
|-----------------|-------|
| Ambient Temp. 1 | 25°C  |
| Ambient Temp. 2 | -15°C |
| Ambient Temp. 3 | -5°C  |
| Ambient Temp. 4 | 5°C   |
| Ambient Temp. 5 | 10°C  |

|                               |      |
|-------------------------------|------|
| Water Temp. A/Ambient Temp. 1 | 40°C |
| Water Temp. B/Ambient Temp. 2 | 37°C |
| Water Temp. C/Ambient Temp. 3 | 33°C |
| Water Temp. D/Ambient Temp. 4 | 29°C |
| Water Temp. E/Ambient Temp. 5 | 25°C |

**H.2.** If no heating curve is desired:

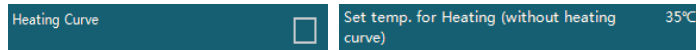

**C.** Configuring the set water cooling temperature (if applicable):

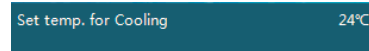

If cooling function is desired, ensure these sections are configured.

3. Locate and activate the buffer tank and appropriate pumps under

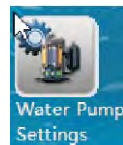



## 2. Assembly Configurations – Drawing 6

---

### Software: Basic Settings (continued)

4. Double-check to ensure that the Domestic Hot Water option is enabled under



5. Configure the desired setpoint for water temperature (default set to 50°C):



## 2. Assembly Configurations – Drawing 7

Please ensure that the configuration matches the assembly drawing depicted on the right for a one temperature zone setup that includes domestic hot water; that also includes a component circuit capable of heating or cooling only, through the use of a two-way motorized valve.

Note: For the cooling-only or heating-only circuit, a motorized two-way valve can be connected to the unit, to cut the water supply during heating or cooling operation.

Refer to the next page for wiring and software operation instructions.

| Name              | Symbol | Name            | Symbol |
|-------------------|--------|-----------------|--------|
| Temp. Sensor      |        | Water pump      |        |
| Safety valve Kit  |        | Mixing valve    |        |
| Ball valve        |        | Motorized valve |        |
| Water filter      |        | Expansion tank  |        |
| Air purging valve |        |                 |        |

Notice: The Fan Coil Unit, Floor Heating System, and Radiator are placeholder distribution systems only and can be substituted by any other appropriate distribution systems.

Note: Dotted lines mean "able to be controlled by the Heat Pump".

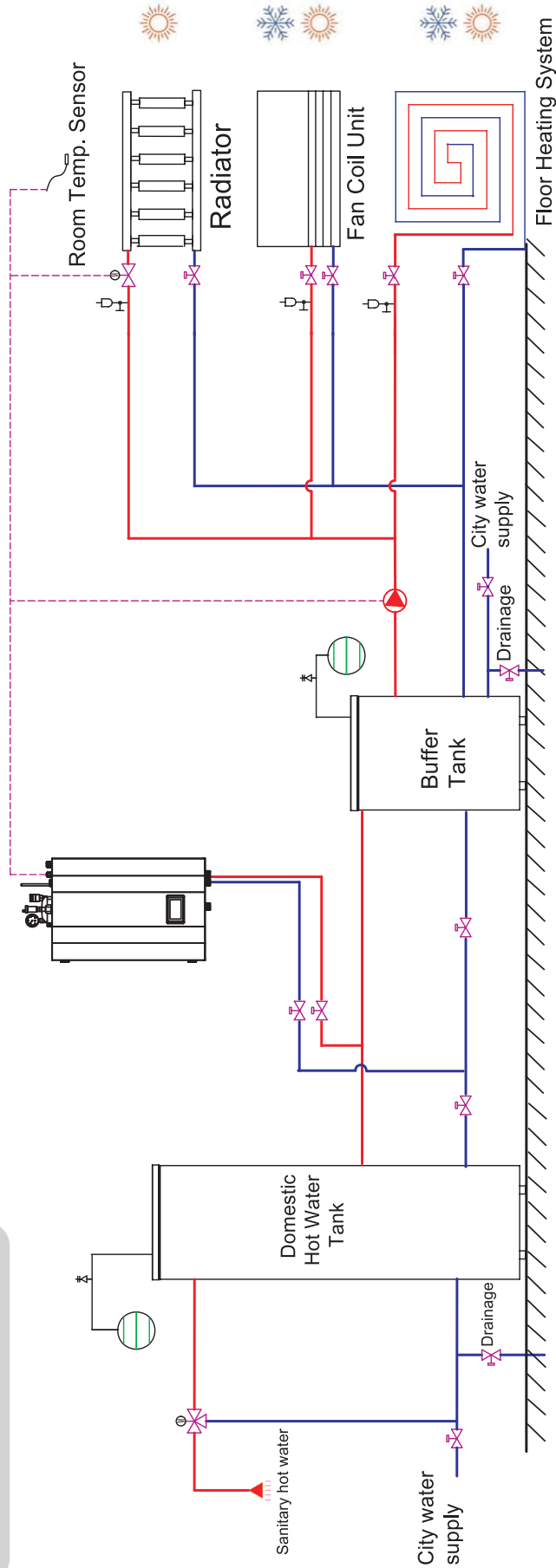

One Temperature Zone, with DHW, with a heating-only (or cooling-only) circuit, by usage of a motorized 2-way valve

## 2. Assembly Configurations – Drawing 7

### Assembly 7: Wiring Diagram

To achieve successful operation at a minimum, ensure the ports below are properly connected.

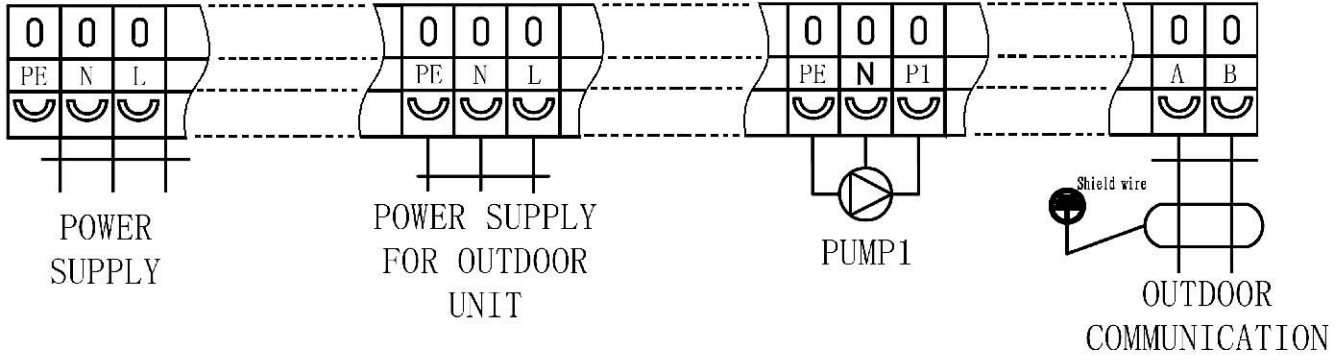

### Software: Basic Settings

1. Set the needed working modes of the unit via the menu

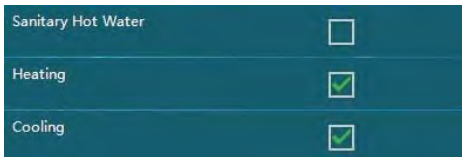
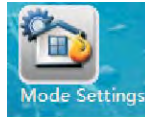

2. Temperature configuration options for Heating/Cooling circuit 1 are found under



**H.** Configuring the set water heating temperatures:

**H.1.** Setting a heating curve:



|                 |       |
|-----------------|-------|
| Ambient Temp. 1 | 25°C  |
| Ambient Temp. 2 | -15°C |
| Ambient Temp. 3 | -5°C  |
| Ambient Temp. 4 | 5°C   |
| Ambient Temp. 5 | 10°C  |

|                               |      |
|-------------------------------|------|
| Water Temp. A/Ambient Temp. 1 | 40°C |
| Water Temp. B/Ambient Temp. 2 | 37°C |
| Water Temp. C/Ambient Temp. 3 | 33°C |
| Water Temp. D/Ambient Temp. 4 | 29°C |
| Water Temp. E/Ambient Temp. 5 | 25°C |

**H.2.** If no heating curve is desired:

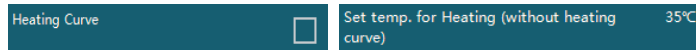

**C.** Configuring the set water cooling temperature (if applicable):

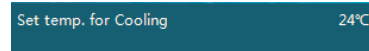

If cooling function is desired, ensure these sections are configured.

3. Locate and activate the buffer tank and appropriate pumps under



## 2. Assembly Configurations – Drawing 7

### Software: Basic Settings (continued)

4. The location of the configuration for heating-only or cooling-only system is under

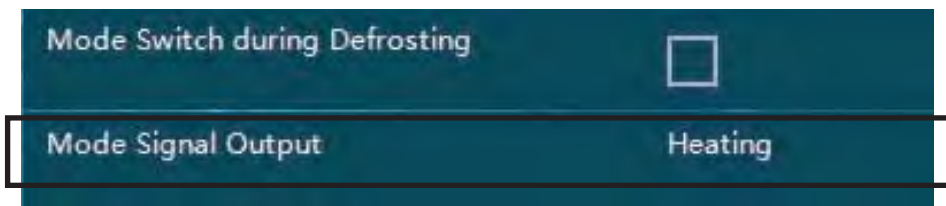
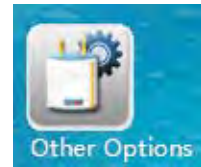

5. Double-check to ensure that the Domestic Hot Water option is enabled under



6. Configure the desired setpoint for water temperature (default set to 50°C):



## 2. Assembly Configurations – Drawing 8

Please ensure that the configuration matches the assembly drawing depicted on the right for a two temperature zone setup that includes domestic hot water.

*Note: Refer to the next page for wiring and software operation instructions.*

| Name              | Symbol | Name            | Symbol |
|-------------------|--------|-----------------|--------|
| Temp. Sensor      |        | Water pump      |        |
| Safety valve Kit  |        | Mixing valve    |        |
| Ball valve        |        | Motorized valve |        |
| Water filter      |        | Expansion tank  |        |
| Air purging valve |        |                 |        |

*Note: Dotted lines mean "able to be controlled by the Heat Pump".*

*Notice: The Fan Coil Unit, Floor Heating System, and Radiator are placeholder distribution systems only and can be substituted by any other appropriate distribution systems.*

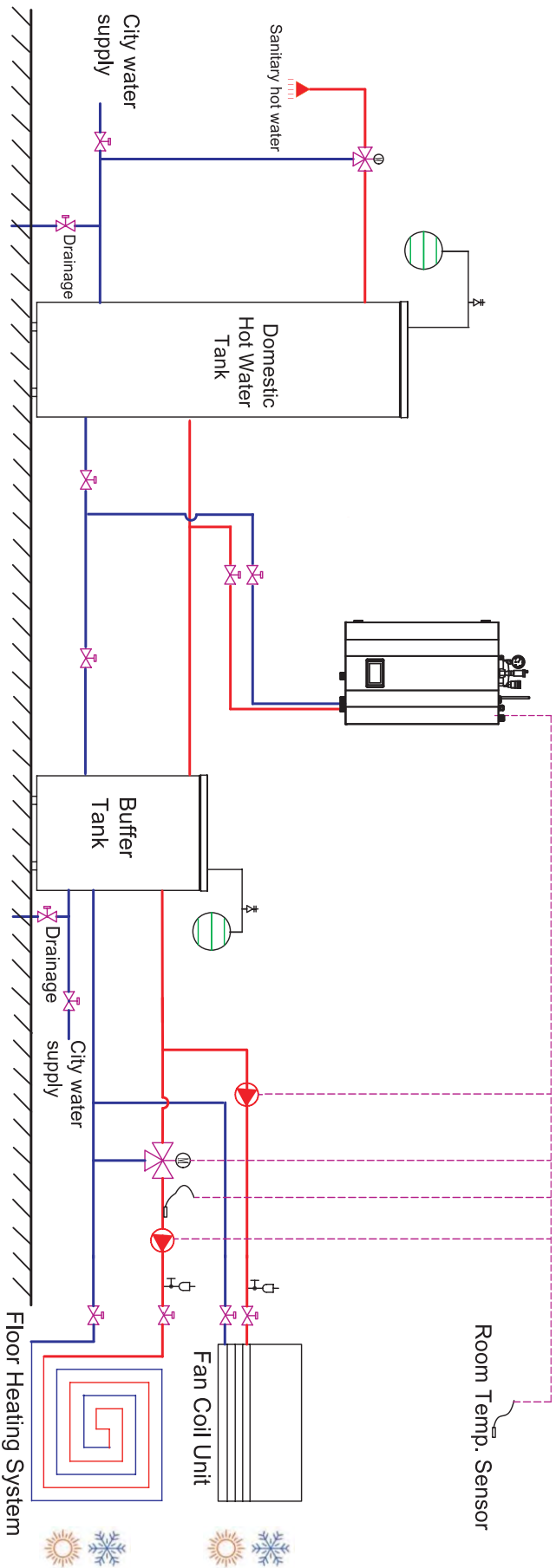

Two Temperature Zone, with DHW

## 2. Assembly Configurations – Drawing 8

### Assembly 8: Wiring Diagram

To achieve successful operation at a minimum, ensure the ports below are properly connected.

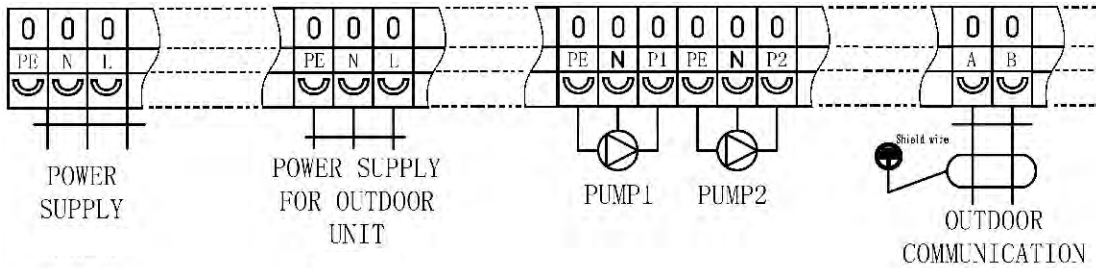

For connection for mixing valve 2, please refer to the appendix A (on page 128-129) of this manual for more information.

### Software: Basic Settings

1. Set the needed working modes of the unit via the menu

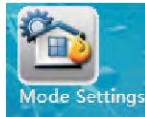

|                    |                                     |
|--------------------|-------------------------------------|
| Sanitary Hot Water | <input type="checkbox"/>            |
| Heating            | <input checked="" type="checkbox"/> |
| Cooling            | <input checked="" type="checkbox"/> |

2. Temperature configuration options for Heating/Cooling circuit 1 are found under



**H.** Configuring the set water heating temperatures:

**H.1.** Setting a heating curve:

|               |                                     |
|---------------|-------------------------------------|
| Heating Curve | <input checked="" type="checkbox"/> |
|---------------|-------------------------------------|

|                 |       |                               |      |
|-----------------|-------|-------------------------------|------|
| Ambient Temp. 1 | 25°C  | Water Temp. A/Ambient Temp. 1 | 40°C |
| Ambient Temp. 2 | -15°C | Water Temp. B/Ambient Temp. 2 | 37°C |
| Ambient Temp. 3 | -5°C  | Water Temp. C/Ambient Temp. 3 | 33°C |
| Ambient Temp. 4 | 5°C   | Water Temp. D/Ambient Temp. 4 | 29°C |
| Ambient Temp. 5 | 10°C  | Water Temp. E/Ambient Temp. 5 | 25°C |

**H.2.** If no heating curve is desired:

|               |                          |   |      |
|---------------|--------------------------|---|------|
| Heating Curve | <input type="checkbox"/> | Set temp. for Heating (without heating curve) | 35°C |
|---------------|--------------------------|---|------|

**C.** Configuring the set water cooling temperature (if applicable):

|                       |      |
|-----------------------|------|
| Set temp. for Cooling | 24°C |
|-----------------------|------|

If cooling function is desired, ensure these sections are configured.

3. Locate and activate the buffer tank and appropriate pumps under



|                           |                                     |
|---------------------------|-------------------------------------|
| Buffer Tank               | <input checked="" type="checkbox"/> |
| P1 for Heating Operation  | <input checked="" type="checkbox"/> |
| P1 for Cooling Operation  | <input checked="" type="checkbox"/> |
| P1 with High Temp. Demand | <input type="checkbox"/>            |

## 2. Assembly Configurations – Drawing 8

### Software: Basic Settings (continued)

3.(cont.) Configure the water pump to operate for heating or cooling:

|                          |                                     |
|--------------------------|-------------------------------------|
| P2 for Heating Operation | <input checked="" type="checkbox"/> |
| P2 for Cooling Operation | <input type="checkbox"/>            |



4. Temperature configuration options for Heating/Cooling circuit 2 are found under

H. configuring the set water heating temperatures:

H.1. Setting a heating curve:

|               |                                     |
|---------------|-------------------------------------|
| Heating Curve | <input checked="" type="checkbox"/> |
|---------------|-------------------------------------|

|                               |      |
|-------------------------------|------|
| Water Temp. A/Ambient Temp. 1 | 40°C |
| Water Temp. B/Ambient Temp. 2 | 37°C |
| Water Temp. C/Ambient Temp. 3 | 33°C |
| Water Temp. D/Ambient Temp. 4 | 29°C |
| Water Temp. E/Ambient Temp. 5 | 25°C |

H.2. If no heating curve is desired:

|               |                          |
|---------------|--------------------------|
| Heating Curve | <input type="checkbox"/> |
|---------------|--------------------------|

|   |      |
|---|------|
| Set Temp. for Heating (without heating curve) | 35°C |
|---|------|

Dependent on whether cooling is needed

C. Configuring the set water cooling temperature (if applicable):

|                       |      |
|-----------------------|------|
| Set temp. For Cooling | 24°C |
|-----------------------|------|

4.1. Activate the mixing valve to manage the second circuit:

|              |                                     |
|--------------|-------------------------------------|
| Mixing Valve | <input checked="" type="checkbox"/> |
|--------------|-------------------------------------|

*Note: This pair of settings will interpret "Heating/Cooling Circuit 2 as the low demand distribution system, requiring a lower set temperature for heating and higher set temperature for cooling.*

5. Double-check to ensure that the Domestic Hot Water option is enabled under

|                    |                                     |
|--------------------|-------------------------------------|
| Sanitary Hot Water | <input checked="" type="checkbox"/> |
|--------------------|-------------------------------------|



6. Configure the desired setpoint for water temperature (default set to 50°C):









|              |      |
|--------------|------|
| Setpoint DHW | 50°C |
|--------------|------|

## 2. Assembly Configurations – Drawing 9

Please ensure that the configuration matches the assembly drawing depicted on the right for a two temperature zone setup that includes domestic hot water, also that includes a component circuit capable of heating or cooling only, through the use of a two-way motorized valve.

*Note: For the cooling-only or heating-only circuit, a motorized two-way valve can be connected to the unit, to cut the water supply during heating or cooling operation.*

*Refer to the next page for wiring and software operation instructions.*

| Name              | Symbol  | Name            | Symbol  |
|-------------------|---|-----------------|---|
| Temp. Sensor      |  | Water pump      |  |
| Safety valve Kit  |  | Mixing valve    |  |
| Ball valve        |  | Motorized valve |  |
| Water filter      |  | Expansion tank  |  |
| Air purging valve |  |                 |   |

*Notice: The Fan Coil Unit, Floor Heating System, and Radiator are placeholder distribution systems only and can be substituted by any other appropriate distribution systems.*

*Note: Dotted lines mean "able to be controlled by the Heat Pump".*

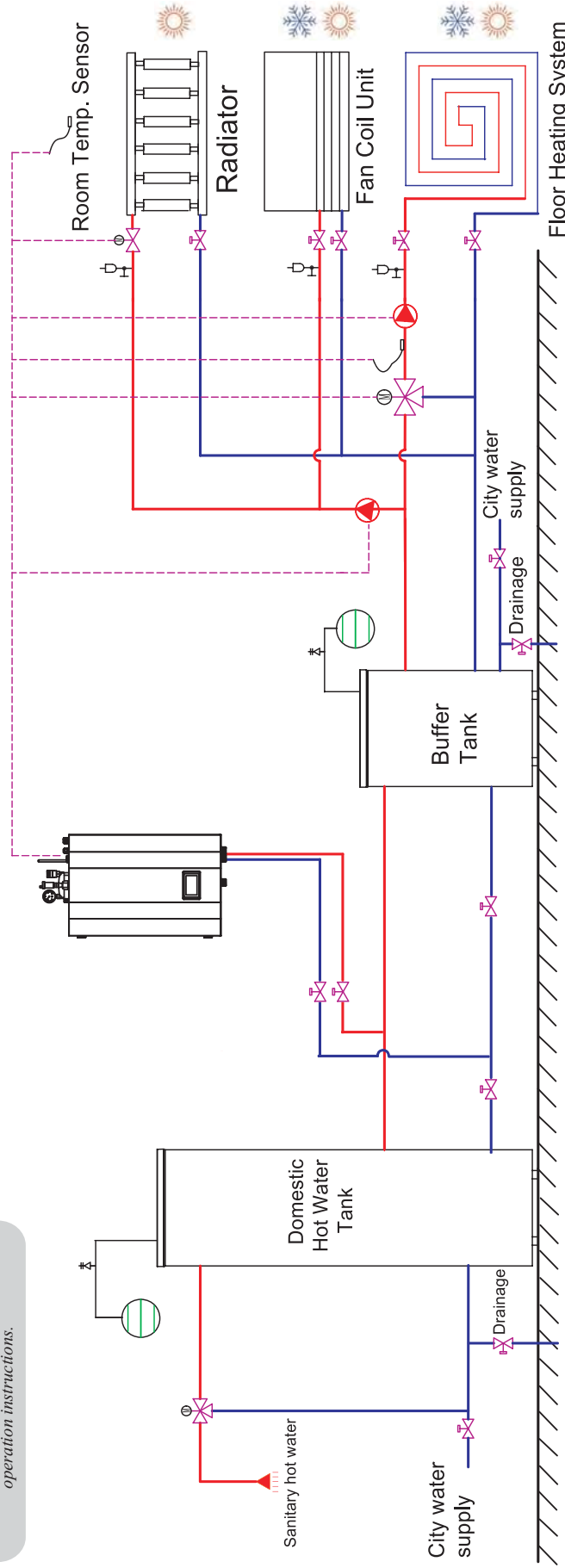

Two Temperature Zones , without DHW, with a heating-only (or cooling-only) circuit, by usage of a motorized 2-way valve



## 2. Assembly Configurations – Drawing 9

### Assembly 9: Wiring Diagram

To achieve successful operation at a minimum, ensure the ports below are properly connected.

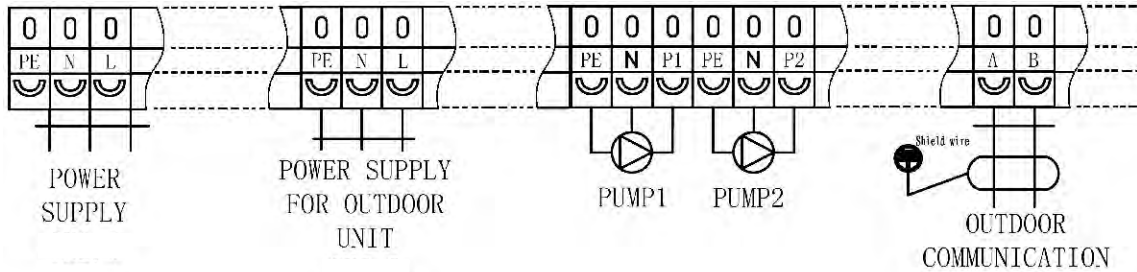

For connection for mixing valve 2, please refer to the appendix A (on page 128-129) of this manual for more information.

### Software: Basic Settings

1. Set the needed working modes of the unit via the menu

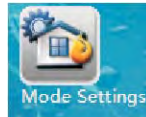

2. Temperature configuration options for Heating/Cooling circuit 1 are found under



**H.** Configuring the set water heating temperatures:

**H.1.** Setting a heating curve:



|                 |       |                               |      |
|-----------------|-------|-------------------------------|------|
| Ambient Temp. 1 | 25°C  | Water Temp. A/Ambient Temp. 1 | 40°C |
| Ambient Temp. 2 | -15°C | Water Temp. B/Ambient Temp. 2 | 37°C |
| Ambient Temp. 3 | -5°C  | Water Temp. C/Ambient Temp. 3 | 33°C |
| Ambient Temp. 4 | 5°C   | Water Temp. D/Ambient Temp. 4 | 29°C |
| Ambient Temp. 5 | 10°C  | Water Temp. E/Ambient Temp. 5 | 25°C |

**H.2.** If no heating curve is desired:

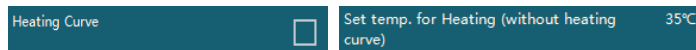

**C.** Configuring the set water cooling temperature (if applicable):

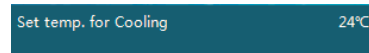

If cooling function is desired, ensure these sections are configured.

3. Locate and activate the buffer tank and appropriate pumps under

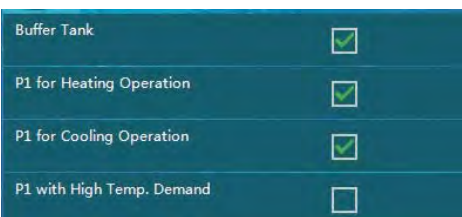
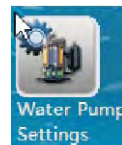

## 2. Assembly Configurations – Drawing 9

### Software: Basic Settings (continued)

3.(cont.) Configure the water pump to operate for heating or cooling:

|                          |                                     |
|--------------------------|-------------------------------------|
| P2 for Heating Operation | <input checked="" type="checkbox"/> |
| P2 for Cooling Operation | <input type="checkbox"/>            |

4. The location of the configuration for heating-only or cooling-only system is under

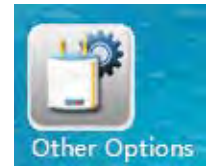

|                               |                          |
|-------------------------------|--------------------------|
| Mode Switch during Defrosting | <input type="checkbox"/> |
| Mode Signal Output            | Heating                  |



5. Temperature configuration options for Heating/Cooling circuit 2 are found under

H. configuring the set water heating temperatures:

H.1. Setting a heating curve:

|               |                                     |
|---------------|-------------------------------------|
| Heating Curve | <input checked="" type="checkbox"/> |
|---------------|-------------------------------------|

|                               |      |
|-------------------------------|------|
| Water Temp. A/Ambient Temp. 1 | 40°C |
| Water Temp. B/Ambient Temp. 2 | 37°C |
| Water Temp. C/Ambient Temp. 3 | 33°C |
| Water Temp. D/Ambient Temp. 4 | 29°C |
| Water Temp. E/Ambient Temp. 5 | 25°C |

H.2. If no heating curve is desired:

|               |                          |
|---------------|--------------------------|
| Heating Curve | <input type="checkbox"/> |
|---------------|--------------------------|

|   |      |
|---|------|
| Set Temp. for Heating (without heating curve) | 35°C |
|---|------|

C. Configuring the set water cooling temperature (if applicable):

|                       |      |
|-----------------------|------|
| Set temp. For Cooling | 24°C |
|-----------------------|------|

5.1. Activate the mixing valve to manage the second circuit:

|              |                                     |
|--------------|-------------------------------------|
| Mixing Valve | <input checked="" type="checkbox"/> |
|--------------|-------------------------------------|

*Note: This pair of settings will interpret “Heating/Cooling Circuit 2 as the low demand distribution system, requiring a lower set temperature for heating and higher set temperature for cooling.*

6. Double-check to ensure that the Domestic Hot Water option is enabled under

|                    |                                     |
|--------------------|-------------------------------------|
| Sanitary Hot Water | <input checked="" type="checkbox"/> |
|--------------------|-------------------------------------|



7. Configure the desired setpoint for water temperature (default set to 50°C):

|              |      |
|--------------|------|
| Setpoint DHW | 50°C |
|--------------|------|

Dependent on whether cooling is needed

# 2. Assembly Configurations – Drawing 10

Please ensure that the configuration matches the assembly drawing depicted on the right for a two temperature zone setup that includes domestic hot water, also that utilizes the secondary pump for a heating-only operation.

*Note: For the heating-only circuit, a motorized two-way valve can be connected to the unit, to cut the water supply during heating operation.  
Refer to the next page for writing and software operation instructions.*

| Name              | Symbol | Name            | Symbol |
|-------------------|--------|-----------------|--------|
| Temp. Sensor      |        | Water pump      |        |
| Safety valve Kit  |        | Mixing valve    |        |
| Ball valve        |        | Motorized valve |        |
| Water filter      |        | Expansion tank  |        |
| Air purging valve |        |                 |        |

Note: Dotted lines mean "able to be controlled by the Heat Pump".

*Notice : The Fan Coil Unit, Floor Heating System, and Radiator are placeholder distribution systems only and can be substituted by any other appropriate distribution systems.*

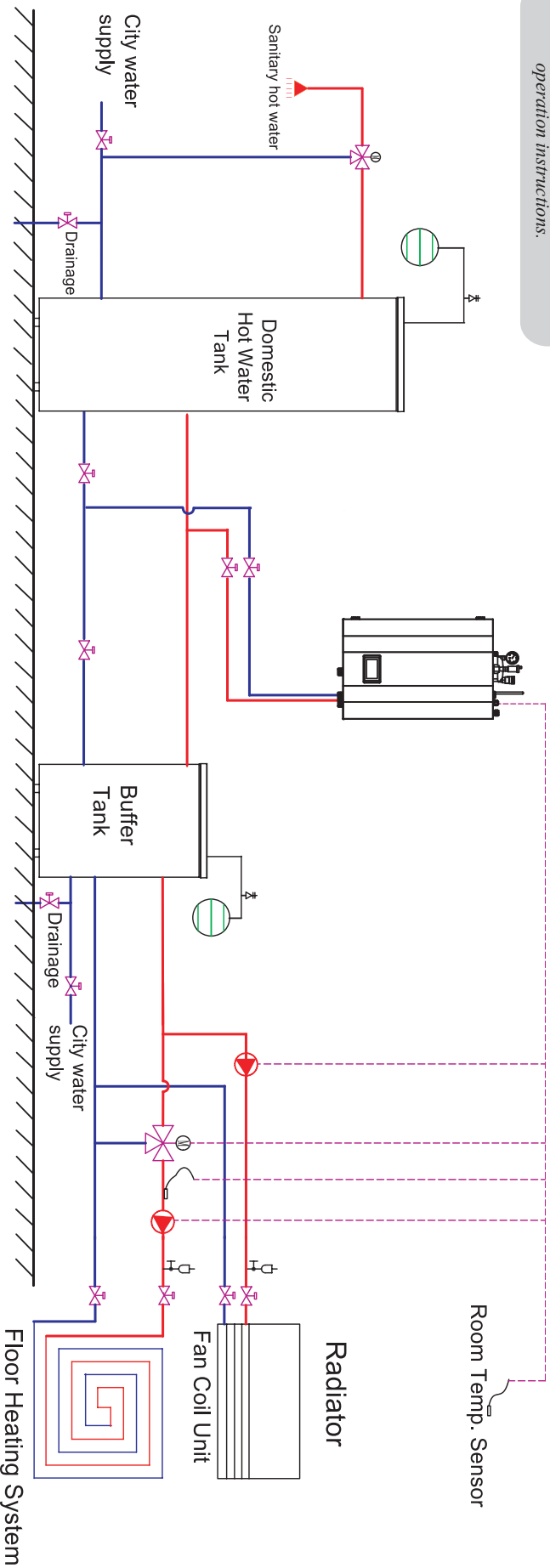

**Two Temperature Zones , without DHW, with a heating-only circuit, by setting the secondary pump to heating-only**

# 2. Assembly Configurations – Drawing 10

## Assembly 10: Wiring Diagram

To achieve successful operation at a minimum, ensure the ports below are properly connected.

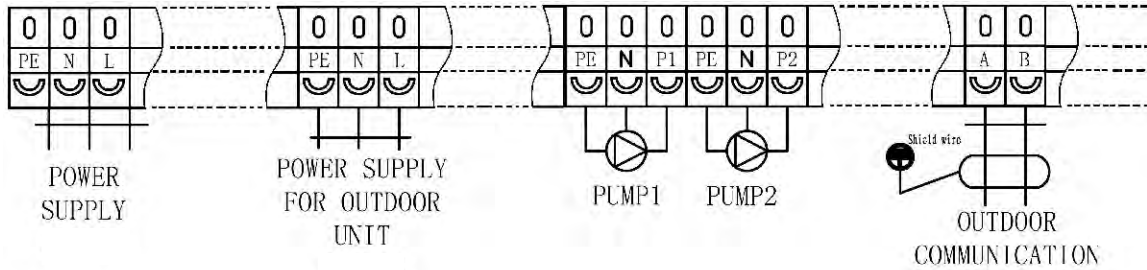

For connection for mixing valve 2, please refer to the appendix A (on page 128-129) of this manual for more information.

## Software: Basic Settings

1. Set the needed working modes of the unit via the menu

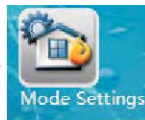

|                    |                                     |
|--------------------|-------------------------------------|
| Sanitary Hot Water | <input type="checkbox"/>            |
| Heating            | <input checked="" type="checkbox"/> |
| Cooling            | <input checked="" type="checkbox"/> |

2. Temperature configuration options for Heating/Cooling circuit 1 are found under



**H.** Configuring the set water heating temperatures:

**H.1.** Setting a heating curve:

|               |                                     |
|---------------|-------------------------------------|
| Heating Curve | <input checked="" type="checkbox"/> |
|---------------|-------------------------------------|

|                 |       |
|-----------------|-------|
| Ambient Temp. 1 | 25°C  |
| Ambient Temp. 2 | -15°C |
| Ambient Temp. 3 | -5°C  |
| Ambient Temp. 4 | 5°C   |
| Ambient Temp. 5 | 10°C  |

|                               |      |
|-------------------------------|------|
| Water Temp. A/Ambient Temp. 1 | 40°C |
| Water Temp. B/Ambient Temp. 2 | 37°C |
| Water Temp. C/Ambient Temp. 3 | 33°C |
| Water Temp. D/Ambient Temp. 4 | 29°C |
| Water Temp. E/Ambient Temp. 5 | 25°C |

**H.2.** If no heating curve is desired:

|               |                          |   |      |
|---------------|--------------------------|---|------|
| Heating Curve | <input type="checkbox"/> | Set temp. for Heating (without heating curve) | 35°C |
|---------------|--------------------------|---|------|

**C.** Configuring the set water cooling temperature (if applicable):

|                       |      |
|-----------------------|------|
| Set temp. for Cooling | 24°C |
|-----------------------|------|

If cooling function is desired, ensure these sections are configured.

3. Locate and activate the buffer tank and appropriate pumps under

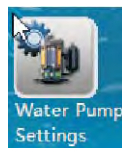

|                           |                                     |
|---------------------------|-------------------------------------|
| Buffer Tank               | <input checked="" type="checkbox"/> |
| P1 for Heating Operation  | <input checked="" type="checkbox"/> |
| P1 for Cooling Operation  | <input checked="" type="checkbox"/> |
| P1 with High Temp. Demand | <input type="checkbox"/>            |

## 2. Assembly Configurations – Drawing 10

### Software: Basic Settings (continued)

3.(cont.) Configure the water pump to operate for heating or cooling:



4. Temperature configuration options for Heating/Cooling circuit 2 are found under

H. configuring the set water heating temperatures:



H.1. Setting a heating curve:



|                               |      |
|-------------------------------|------|
| Water Temp. A/Ambient Temp. 1 | 40°C |
| Water Temp. B/Ambient Temp. 2 | 37°C |
| Water Temp. C/Ambient Temp. 3 | 33°C |
| Water Temp. D/Ambient Temp. 4 | 29°C |
| Water Temp. E/Ambient Temp. 5 | 25°C |

H.2. If no heating curve is desired:



|   |      |
|---|------|
| Set Temp. for Heating (without heating curve) | 35°C |
|---|------|

C. Configuring the set water cooling temperature (if applicable):



4.1. Activate the mixing valve to manage the second circuit:



*Note: This pair of settings will interpret “Heating/Cooling Circuit 2 as the low demand distribution system, requiring a lower set temperature for heating and higher set temperature for cooling.*

5. Double-check to ensure that the Domestic Hot Water option is enabled under



6. Configure the desired setpoint for water temperature (default set to 50°C):



# 3. Installation

## 3.1 General application system introduction

### 3.1.1 Sanitary hot water

For safety purpose, it is recommended to set up the sanitary hot water system as shown below:

#### 1) Application 1

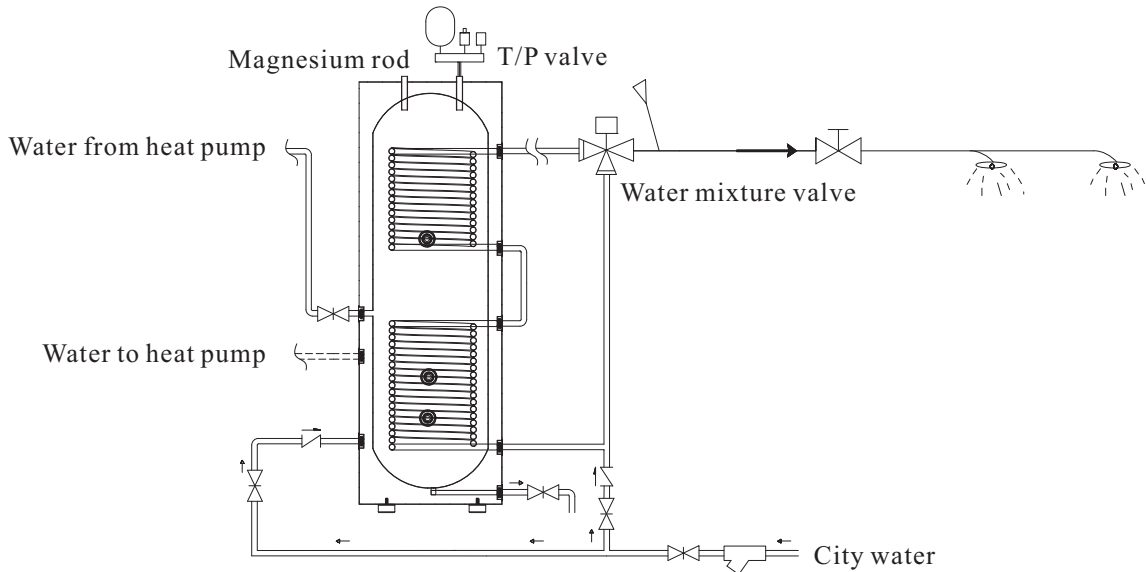

After heat pump is connected directly with the tank, city water will be heated up by hot water in the tank when it runs through a long coil inside the tank.

Disadvantage of this application is that heat is transferred from hot water in the tank to city water in the coil, thus it will have less volume of sanitary hot water available compared with other solutions.

The advantages of this application is:

- A. Heat pump is connected with tank directly, so it can effectively ensures the water flow rate inside heat pump system.
- B. Sanitary hot water is heated up by going through the coil, which makes it unnecessary to have sanitization. This will help the system save more energy.

# 3. Installation

## 2) Application 2

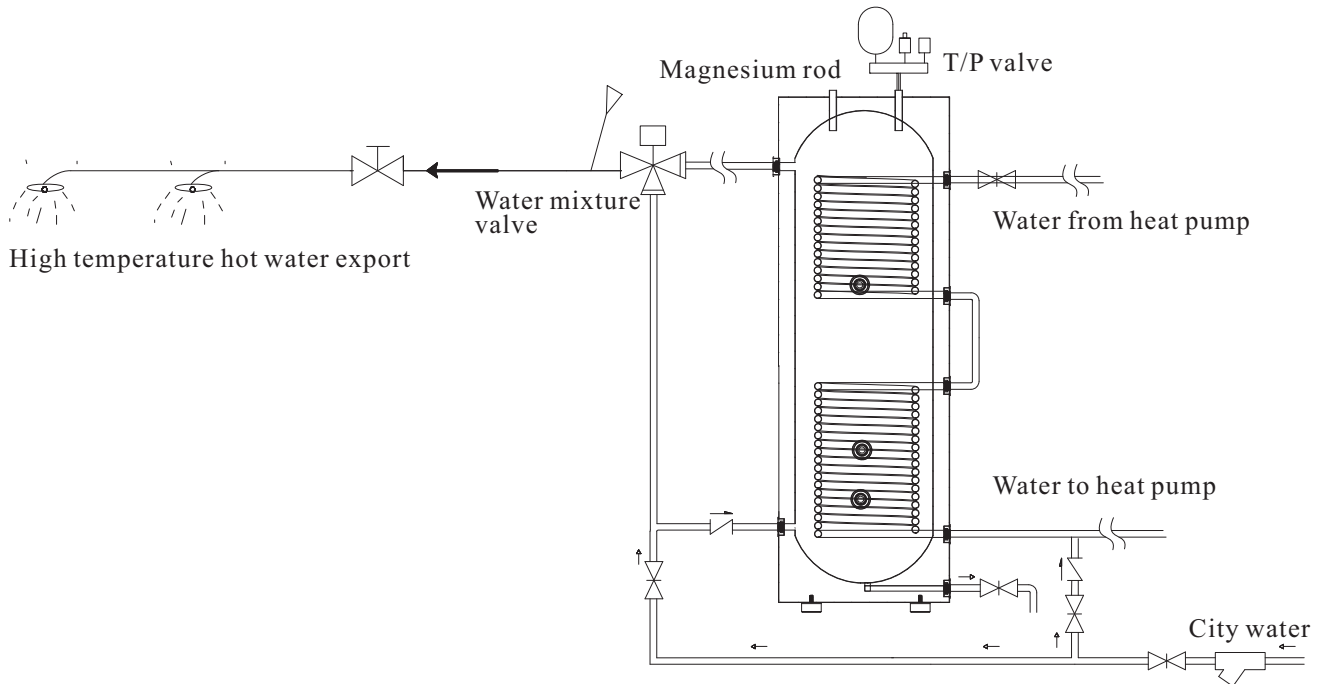

By connecting the set of coil with heat pump directly, the safety of sanitary hot water inside the tank, is also ensured.

However, the capacity of the coil should be bigger than the maximum output of the unit (heat pump output at A7/W45). Usually this solution is used for working together with a heat pump whose capacity is less than 14kW.

The advantage of this application is that it can supply bigger volume of hot sanitary hot water.

The disadvantage of this application is that this coil may create big water flow resistance to heat pump water circuit. Thus it may need to add a secondary water pump to ensure the flow rate of heat pump unit. Otherwise it may affect unit efficiency or make the unit work improperly.

# 3. Installation

## 3) Application 3

A water to water plate heat exchanger can be used instead of the coil inside water tank, as shown below:

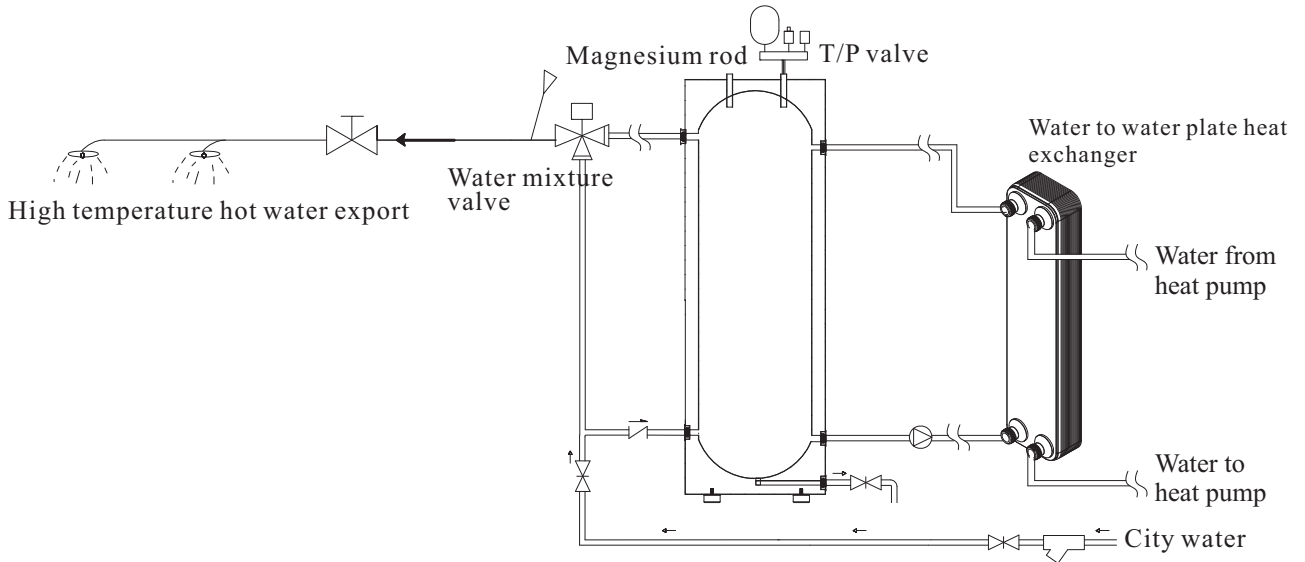

With this application, it can not only ensure the volume of high temperature hot water, but also ensure the water flow rate of heat pump system. But the total cost will be higher than other two applications due to the cost the plate heat exchanger.

For all these three applications, it is recommended to add a manual mixture valve between city water inlet and water tank sanitary hot water outlet. This can maximize the utilization of hot water in the tank and also ensures its temperature won't be too high to burn people.

If the structure of the tank permits, it is suggested to use a manual 4-way mixture valve in sanitary hot water system as shown below. This can further improve the utilization of hot water in the tank.

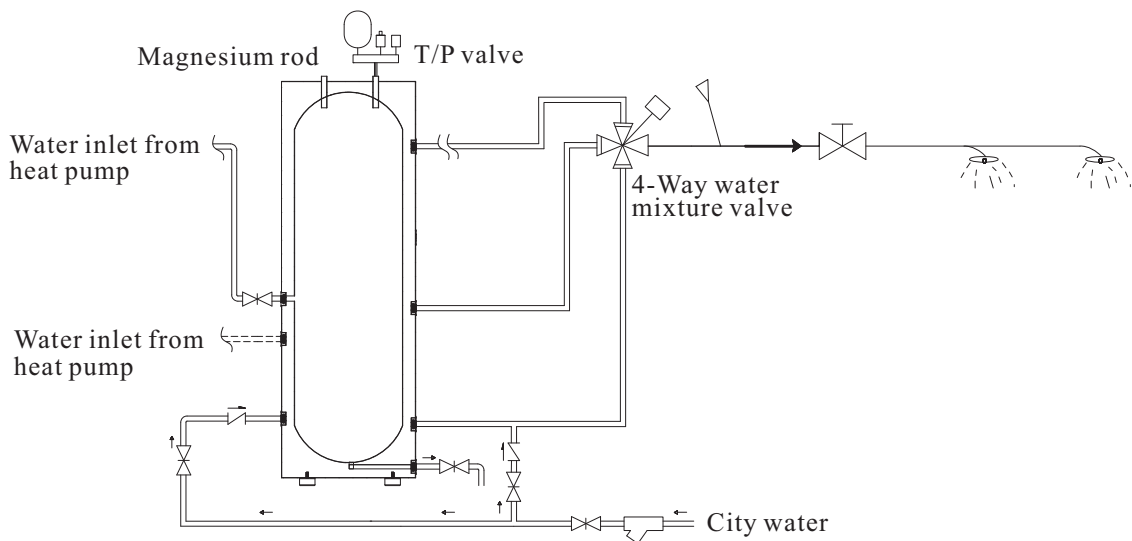



# 3. Installation

## 3.1.2 Heater /cooling distribution system

**Note:**

Buffer tank is always recommended to be included in the system , especially when the distribution system has water volume less then 20L/W. It should be installed between heat pump and distribution system , in order to:

- 1) Ensure heat pump unit has stable and enough water flow rate.
- 2) Store heat to minimize fluctuation of system heating/cooling load.
- 3) Extend the water volume of distribution system for proper working of heat pump unit.

If distribution system has enough water volume and can ensure the water flow rate of heat pump system , buffer tank can be excluded in the system . But in this way , please move temperature sensor Tc (Cooling/heating temperature sensor ) to water return pipe to minimize the fluctuation of water temperature caused by compressor speed changes.

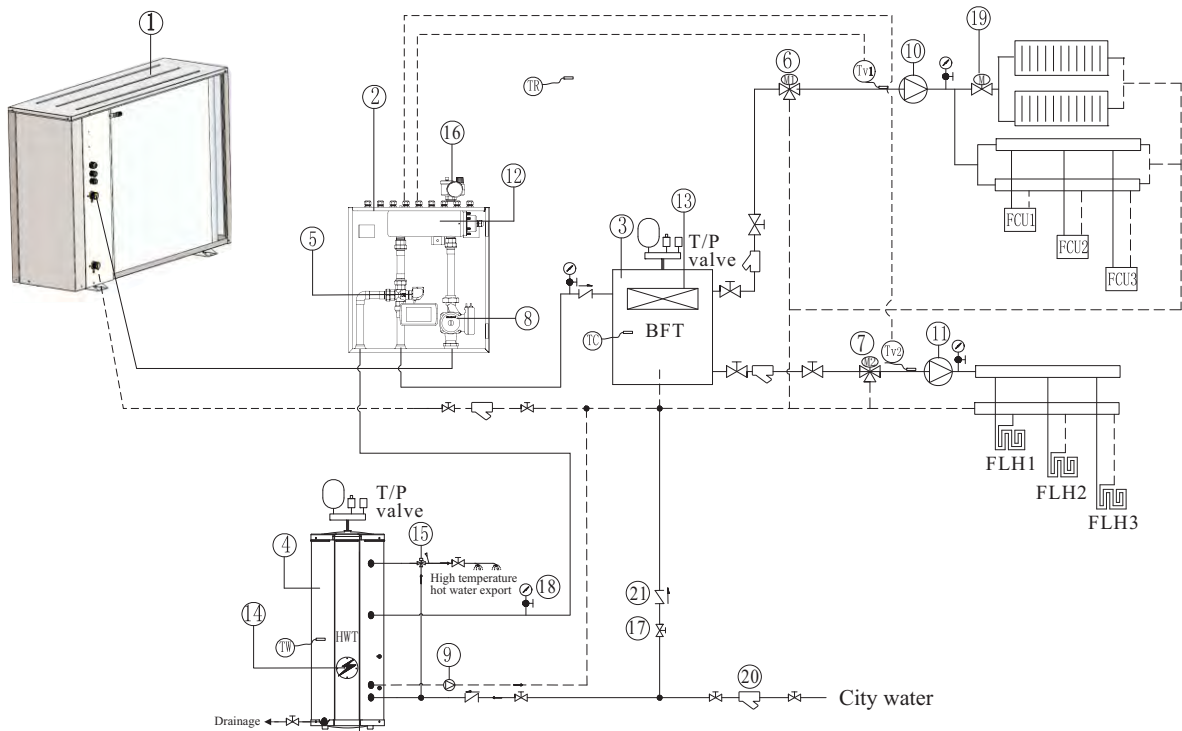

| Item | Name   |
|------|--|
| 1    | Monoblock unit                               |
| 2    | Indoor control unit                          |
| 3    | Buffer tank                                  |
| 4    | Sanitary hot water storage tank              |
| 5    | Motorized 3-way valve                        |
| 6    | Mixture valve 1 (0~10V)                      |
| 7    | Mixture valve 2 (0~10V)                      |
| 8    | Circulation pump                             |
| 9    | Sanitary hot water circulation pump(if need) |
| 10   | Circulation pump for distribution system 1   |
| 11   | Circulation pump for distribution system 2   |
| 12   | AH-Auxiliary heater inside unit              |
| 13   | HBH-Heating Back-up Heater                   |
| 14   | HWTBH-Hot Water Tank Back-up Heater          |
| 15   | Sanitary hot water mixture valve             |

| Item | Name                                       |
|------|--|
| 16   | Safety valve kit                           |
| 17   | Ball valve                                 |
| 18   | Pressure meter                             |
| 19   | Motorized 2-way valve                      |
| 20   | Filter                                     |
| 21   | One-way valve                              |
| TW   | Hot water temperature                      |
| TC   | Cooling or heating water temperature       |
| TR   | Room temperature                           |
| Tuo  | Monoblock unit outlet water temperature    |
| Tui  | Monoblock unit return water temperature    |
| Tup  | Monoblock unit coil temperature            |
| Tv1  | Temperature of water after mixture valve 1 |
| Tv2  | Temperature of water after mixture valve 2 |

## 3. Installation

### 3.1.3 Heating&Cooling Circuits:

This heat pump unit can control two totally different heating/cooling circuit, as shown in the drawing.

Temperature setting can be made via menu “Heating & Cooling Circuit 1” and “Heating & Cooling Circuit 2”.

Of course, if only one circuit is needed, “heating&cooling circuit 2” in system drawing can be omit, and leave the “Heating&cooling Circuit 2” under “heating&cooling circuit 2” set to OFF:

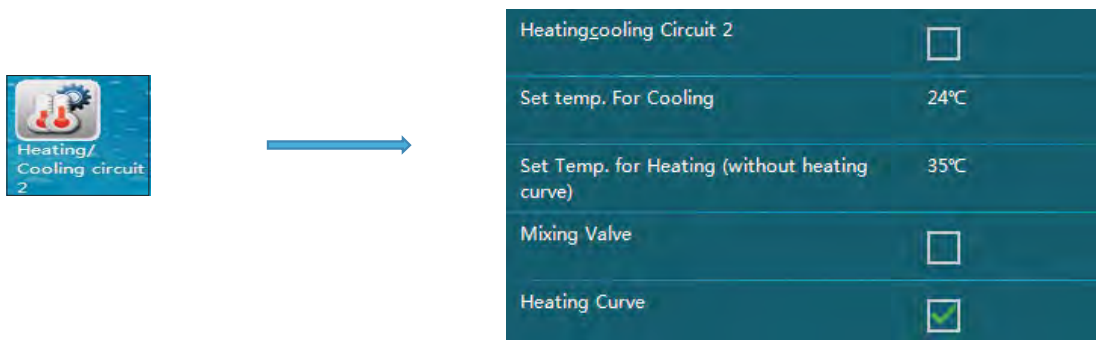

### 3.1.4 Heating & Cooling Circuit 1

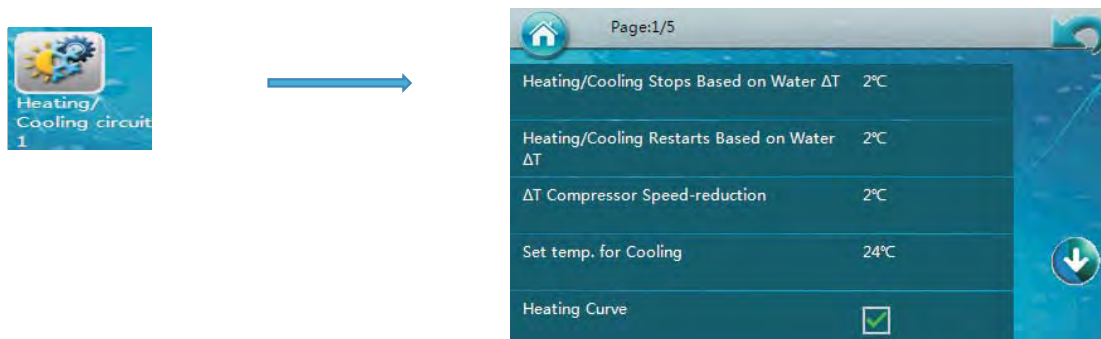

#### Control of Mixing Valve 1(MV1):

If system water temperature may higher(lower) than temperature that are need for circuit 1 in heating (cooling) operation, then a mixing valve can be add to circuit 1, and connected to MV1 port in indoor unit.

Unit will control the mixing valve, mix the supply and return water of circuit 1 to have the temperature read via sensor TV1 get to value set under menu “Heating & Cooling Settings circuit1”.

If so, TV1 under menu ““Heating & Cooling circuit1” should be activated under installer’s level:

## 3. Installation

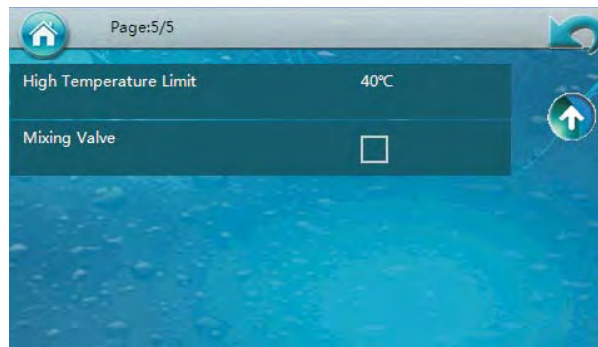

**Note:** If TV1 is not connected, while it is activated via setting here, unit will show relative failure code.

### 3.1.5 Heating & Cooling circuit 2

#### Control of Mixing Valve 2(MV2):

If system water temperature may higher(lower) than temperature that are need for circuit 2 in heating (cooling) operation, then a mixing valve can be added to circuit 2, and connected to MV2 port in indoor unit.

Unit will control the mixing valve, mix the supply and return water of circuit 2 to have the temperature read via sensor TV2 get to value set under menu “Heating & Cooling Settings circuit 2”.

If so, TV2 under menu “Heating & Cooling Settings circuit 2” should be activated under installer’s level:

**Note:** If TV2 is not connected, while it is activated via setting here, unit will show relative failure code.



#### Tips:

##### When Mixing valve is needed?

In general, if system water temperature may higher(lower) than temperature that are need for this circuit, then a mixing valve is needed.

A.If a system has two circuits, these two circuits may require different water temperatures. Heat pump has to take the higher(lower) setting among two circuits as the set temperature for heat pump when it works in heating(cooling). Thus, a mixing valve is needed for the circuit that with lower(higher) setting to ensure it gets water with correct temperature circulates in the circuit.

B.If a system has other heating source inside that is out the control of heat pump (e.g. Solar system), as the actual water temperature may exceed the set temperature of heat pump, a mixing valve is also needed to ensure the circuit gets water with correct temperature circulates in the circuit.

# 3. Installation

## Control of Circulation Pump for circuit 1&2:



|                           |                          |
|---------------------------|--------------------------|
| Buffer Tank               | <input type="checkbox"/> |
| P1 for Heating Operation  | <input type="checkbox"/> |
| P1 for Cooling Operation  | <input type="checkbox"/> |
| P1 with High Temp. Demand | <input type="checkbox"/> |
| P2 for Heating Operation  | <input type="checkbox"/> |
| P2 for Cooling Operation  | <input type="checkbox"/> |
| P2 with High Temp. Demand | <input type="checkbox"/> |

“With/without Buffer Tank”: Set whether it has a buffer tank between heat pump unit and distribution system or not.

“P1 for Heating Operation” means circuit pump for circuit 1 should work for heating operation.

“P1 for Cooling Operation” means circuit pump for circuit 1 should work for cooling operation.

“P2 for Heating Operation” means circuit pump for circuit 2 should work for heating operation.

“P2 for Cooling Operation” means circuit pump for circuit 2 should work for cooling operation.

If “without buffer tank” is set, both P1 (circulation pump for circuit 1) and P2 (circulation pump for circuit 2) will only work when compressor is working in the same mode as the pump is set to. For example, if P1 is set to “P1 for Heating Operation”, P1 will be turned ON only when compressor is working in heating mode. If both “P1 for Heating Operation” and “P1 for Cooling Operation” are both selected, P1 will be turned ON when compressor is working in both heating and cooling mode. When heat pump switches to DHW mode or stops after get the set temperature for heating or cooling, pump stops.

If “with buffer tank” is set, both P1 (circulation pump for circuit 1) and P2 (circulation pump for circuit 2) will work once the distribution system has the heating or cooling demand, as per the pump setting, and obeys following rules:

Actual temperature in buffer tank detected via  $T_c \geq 20^\circ\text{C}$  in heating. Only  $20^\circ\text{C}$  and above can be useful for distribution system in heating operation.

Actual temperature in buffer tank detected via  $T_c \leq 23^\circ\text{C}$  in cooling. Only  $23^\circ\text{C}$  and below can be useful for distribution system in cooling operation.

For example, if P1 is set to “P1 for Heating Operation”, P1 will start to work as long as the system has heating demands and  $T_c$  reading is no lower than  $20^\circ\text{C}$ , even if the unit is working in DHW mode or stops after get the set temperature.

“Working of P1(2) with High Demanding Signal” means whether P1(P2) should stop if signal for “high demanding” is off. For detailed meaning of “High Demanding Signal”, please refers to part “D” of “Terminal Block 4” of chapter “2.5.1”, “High demanding distribution system switch”.

### 3.1.6 Room temperature sensor :

Room temperature sensor ( $T_r$ ) is recommended to be placed in a ideal position of the house to check the room temperature. Thus the unit can have room temperature control mode (please refers to 9.04 Basic Operation), and room temperature compensate function (please refers to 1.16 Room temp. effect on Heating Curve).

## 3. Installation

### 3.2 Tools needed

Most people already have the tools needed for installation: spirit level, pencil, crosshead screwdriver, drill, 8 mm. concrete drill bit, detection drill, square, tape measure or ruler, tape width 65 mm, hole saw about 80 mm (deviation in size may occur), knife and two adjustable spanners or pliers (and possibly torque wrench).



The installation of the product should be handled by professional installers or under their instructions.

### 3.3 Installation of the indoor control unit

#### 3.3.1 Installation notes

- 1) The indoor control unit should be installed indoors and mounted on the wall, with water outlet downwards.
- 2) The indoor control unit shall be placed in dry and well-ventilated environment.
- 3) Indoor control unit mustn't be installed in an environment where volatile, corrosive or flammable liquid or gas exists.
- 4) Enough space should be left around the indoor control unit for further maintenance.  
Please choose a suitable position to install the indoor control unit as follows:

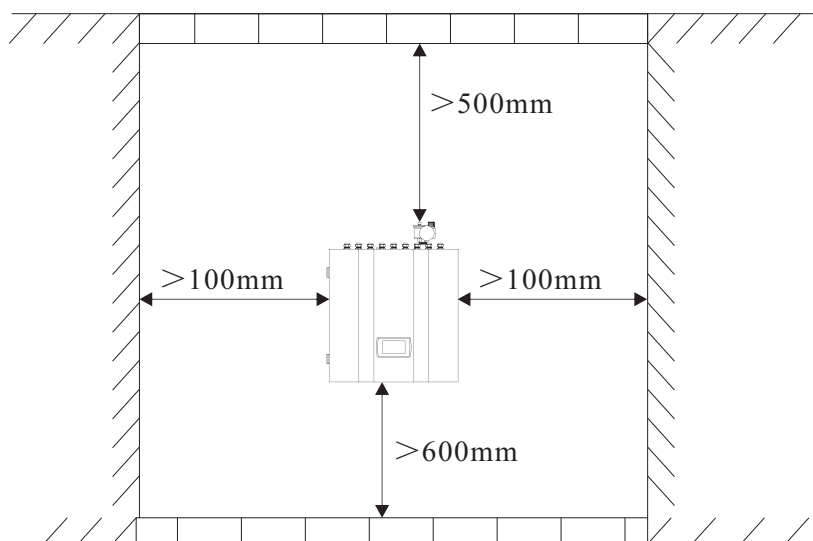

# 3. Installation

## 3.3.2 Installation

Indoor control unit should be mounted on the wall as per procedures below:

- 1) Take out the expansion bolts and mounting board from accessory and put the mounting board on the wall horizontally; Mark on the wall the location for bolts through the holes on mounting board.
- 2) Drill holes with proper diameter for expansion bolts.
- 3) Unscrew the nuts out from the expansion bolts.
- 4) Fix the mounting board on the expansion bolts a little bit, but don't be too tight.
- 5) Use a hammer to pound the expansion bolts into the drilled holes. Fasten the nuts by turning the wrench to fix the mounting board on the wall.
- 6) Hang the indoor control unit onto the mounting board and make sure it's placed well before you let go your hands. The installation is finished.

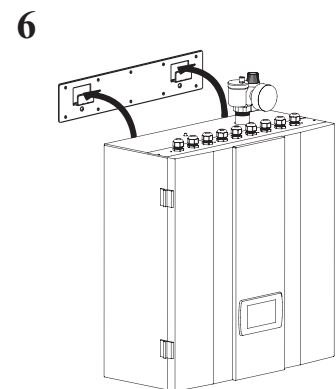
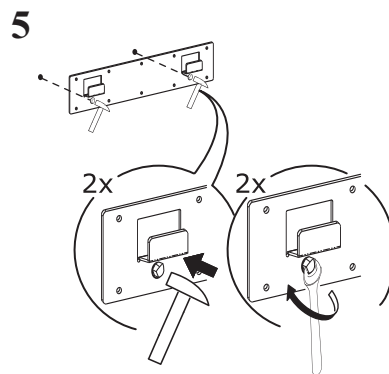
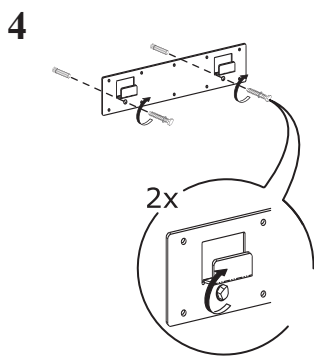
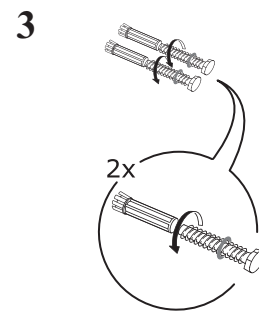
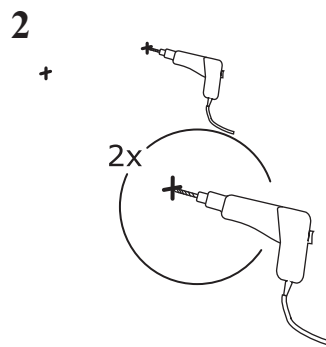
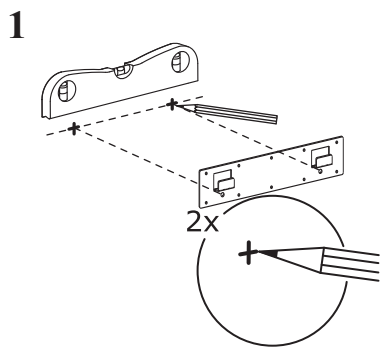

### Note:

**You must choose very firm wall for installation otherwise the bolts may get loose and unit be damaged!**



If it's wood wall, please use self-tapping screws in accessory instead of expansion bolts. Please hang the mounting board directly onto the wood wall without drilling holes. The wood wall must be firm enough. Wood walls that are too thin, too brittle or humid are not adequate for installation.

## 3. Installation

### 3.4 Installation of the monoblock unit

#### 3.4.1 Installation notes

- 1) The monoblock unit can be located in a open space, corridor, balcony, and roof.
- 2) The monoblock unit shall be placed in dry and well-ventilated environment; If the monoblock unit is installed in humid environment, electronic components may get corroded, or short-circuited because of heavy humidity.
- 3) Monoblock unit mustn't be installed in an environment where volatile, corrosive or flammable liquid or gas exists.
- 4) Please don't install monoblock unit close to bedroom or living room, because there is some noise when it's running.
- 5) When installing the unit in harsh climatic conditions, sub-zero temperatures, snow, humidity..., please raise the unit above the ground by about 50cm.  
It's recommended to install an awning above the monoblock unit, to protect the snow from clogging in the air inlet and outlet and ensure the normal running.
- 6) Please ensure there is drainage system around the location, to drain the condensate water under defrosting mode.
- 7) When installing the unit, tilt it by 1cm/m for rain water evacuation.
- 8) Install monoblock unit far away from the exhaust port of kitchen, to avoid oil smoke entering into monoblock unit and adhering to heat exchanger. It's hard to clean up.
- 9) Please don't install the indoor control unit and monoblock unit in damp locations, otherwise it may cause short-circuit or corrosion of some components. The unit should be free from corrosive and moisture surrounding. Otherwise the lifetime of the unit might be shortened.
- 10) Please ensure enough space around the monoblock unit, for better ventilation and maintenance.  
Please refer to the illustration below.

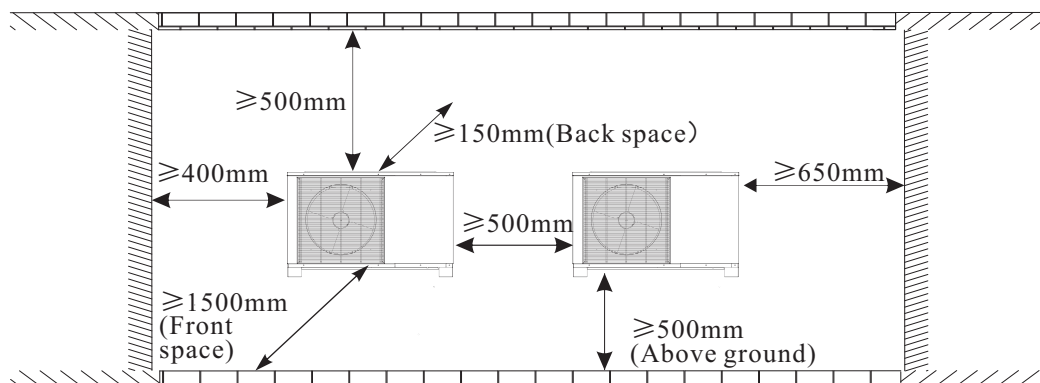

# 3. Installation

## 3.4.2 Installation

User can either use the dedicated mounting bracket from the supplier, or prepare a suitable bracket for the unit installation. Make sure the installation meets following requirements:

- 1) The unit must be installed on flat concrete blocks, or a dedicated mounting bracket. The bracket should be able to support at least 5 times of unit's weight.
- 2) All nuts must be tightened after the bracket is fixed; otherwise, it may cause damage to the equipment.
- 3) User should double check and make sure the installation of unit is firm enough.
- 4) The bracket can be of stainless steel, galvanized steel, aluminum and other materials as required by the user.
- 5) Besides the mounting bracket, the user can also install the monoblock unit on two concrete blocks, or a raised concrete platform. Please make sure that the unit is securely fastened after installation.
- 6) Please see the dimensions of monoblock unit when choose a suitable wall bracket.

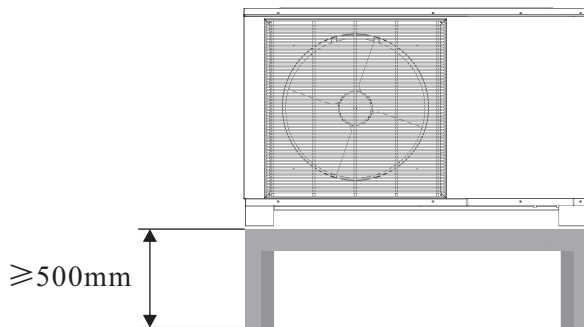

- ◆ Hole for piping kits should lean to outside a little bit ( $\geq 8$  degrees), to keep rain water or condensate water from flowing back indoors.

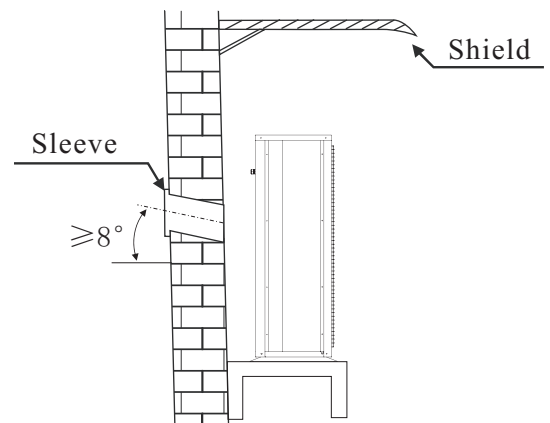













## 3. Installation



### 3.5 Accessories



Accessories below are delivered together with the product .  
Please check in time. If there is any shortage or damage, please contact local distributor.

| Name             | Quantity | Picture   |
|------------------|----------|---|
| User's manual    | 1        |  |
| Drain pipe       | 1        |  |
| Safety valve kit | 1        |  |

| Name   | Quantity | Picture   |
|--|----------|---|
| TR-Room temperature sensor   | 1        |   |
| TC-water temperature sensor for cooling and heating  | 1        |  |
| TW-water temperature sensor for sanitary hot water   | 1        |  |
| TV1-water temperature sensor after mixture valve 1<br>TV2-water temperature sensor after mixture valve 2 | 1        |  |
| Communication cable between indoor control unit and monoblock unit                                       | 1        |  |
| Communication cable  | 8        |  |
| Signal cable between indoor control unit and monoblock unit  | 1        |  |

| Name                        | Quantity | Picture   |
|-----------------------------|----------|---|
| Indoor control unit bracket | 1        |  |
| Expansion bolts             | 2        |  |

# 3. Installation

## 3.6 Wiring

### 2.6.1 Explanation of terminals

#### 1) Terminal block 1

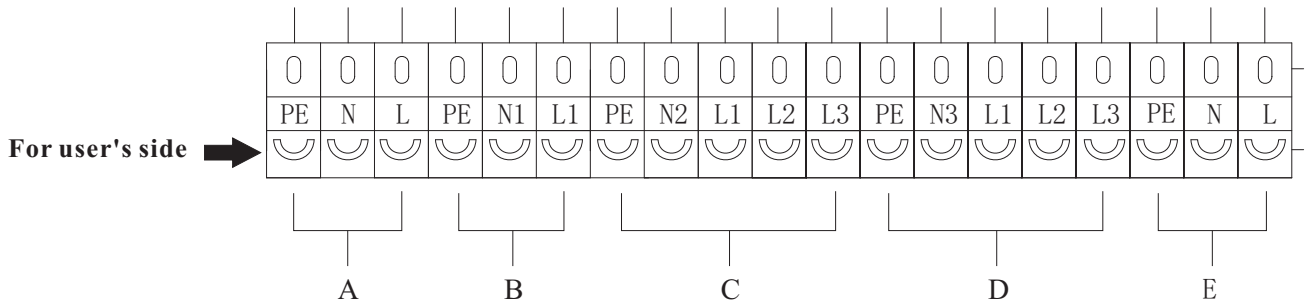

A: Unit power supply (Power Cord: H05VV-F 3×2.5mm<sup>2</sup>)  
 Unit power supply. Should be connected to city power input.

B: Power supply for AH-Auxiliary heater inside unit(Power Cord: H05VV-F 3×1.5mm<sup>2</sup>,  
 city power input)

This should be connected to city power supply, 1 phase. It is for giving the power to auxiliary heater inside the indoor control unit.

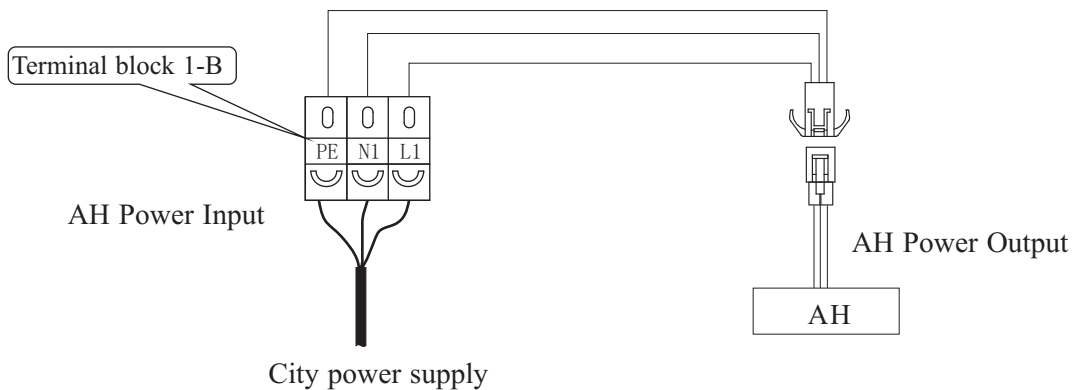

C: Power supply for HWTBH-Hot Water Tank Back-up Heater(Power Cord: H05VV-F 3×1.5mm<sup>2</sup>,  
 city power input)

If sanitary hot water tank has electric heater inside, one can connect this heater to heat pump unit, so to have it under the control of heat pump.

In that way, city power input (1 phase or 3 phase) should be connected to this port “Electrical Heater Power Supply for Hot Water 5×1.5mm<sup>2</sup>”.

### 3. Installation

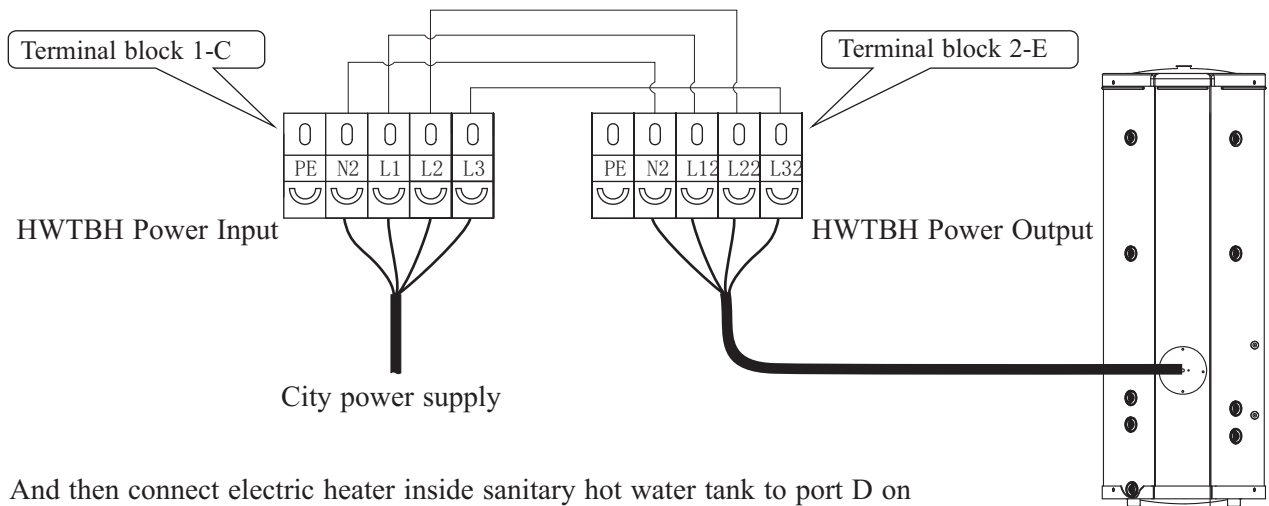

And then connect electric heater inside sanitary hot water tank to port D on terminal block 2.

#### D: Power supply for HBH-Heating Back-up Heater (Power Cord: H05VV-F 5×1.5mm<sup>2</sup>, city power input)

When the house heating system also has a electric heater as a back-up, then this heater can also be connected to heat pump unit and under heat pump's control.

In that way, city power input (1 phase or 3 phase) should be connected to this port "Reserved Electrical Heater Power Supply 5×1.5mm<sup>2</sup>", and then heater should be connected to port E on terminal block 2.

PS: If external heating source (on house heating circuit or hot water circuit) is not electric heater but other heating sources, we can also connect it to the heat pump like this if they can be controlled by electric signal, to have them under the control of heat pump.

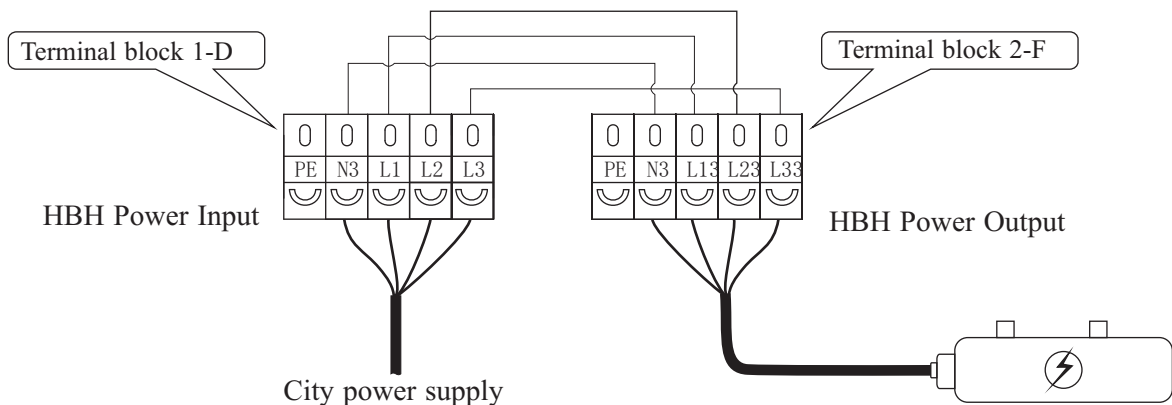

#### E: Monoblock unit power supply (Power Cord: H05VV-F 3×2.5mm<sup>2</sup>, output)

Monoblock unit power cable should be connected with these terminals so to get power from indoor control unit.

# 3. Installation

## 2) Terminal block 2

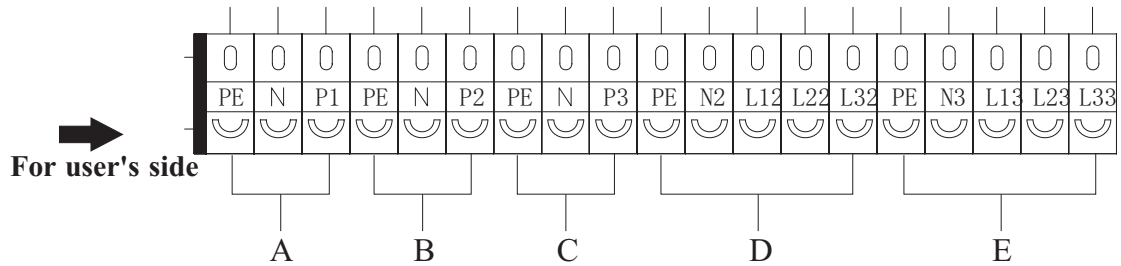

**A, B, C: Water Pump**

A-Pump 1: Circulation pump (heating)

B-Pump 2: Circulation pump (cooling)

C-Pump 3: Circulation pump (hot water)

Pump 0: DC pump inside the indoor control unit.

If there is an external water pump in heating, cooling and hot water system, it can be connected to these ports, to be under the control of heat pump,

**D: Power supply for HWTBH-Hot Water Tank Back-up Heater (Power Cord: H05VV-F 3×1.5mm<sup>2</sup>, power output)**

Refer to explanation of port C of terminal block 1.

**E: Power supply for HBH-Heating Back-up Heater (Power Cord: H05VV-F 5×1.5mm<sup>2</sup>, power output)**

Refer to explanation of port D of terminal block 1.

# 3. Installation

## Explanation of connectors for other heating sources

### A: HWTBH-Hot water tank back-up heater

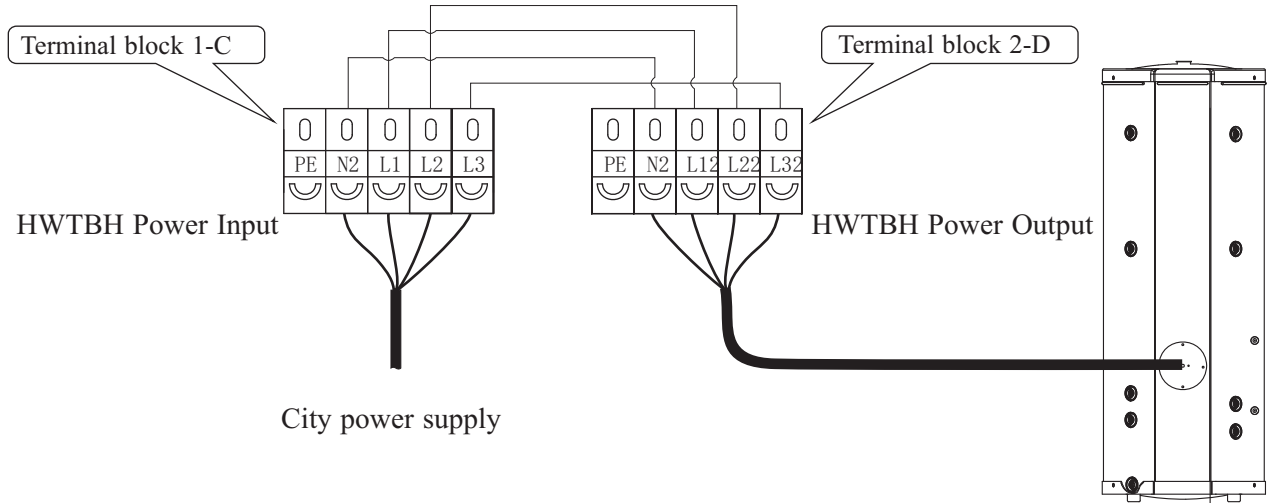

### B: HBH-Heating back-up heater

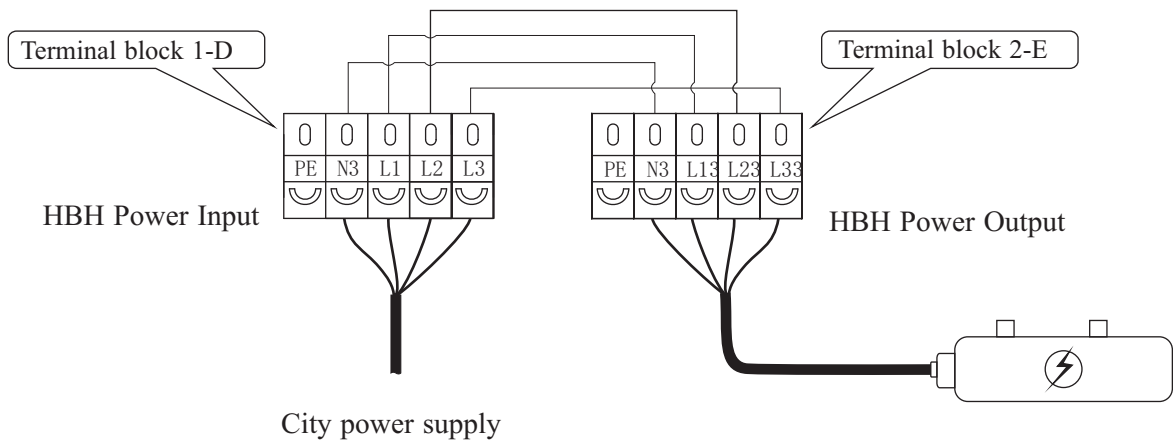

## 3. Installation

### 3) Terminal block 3

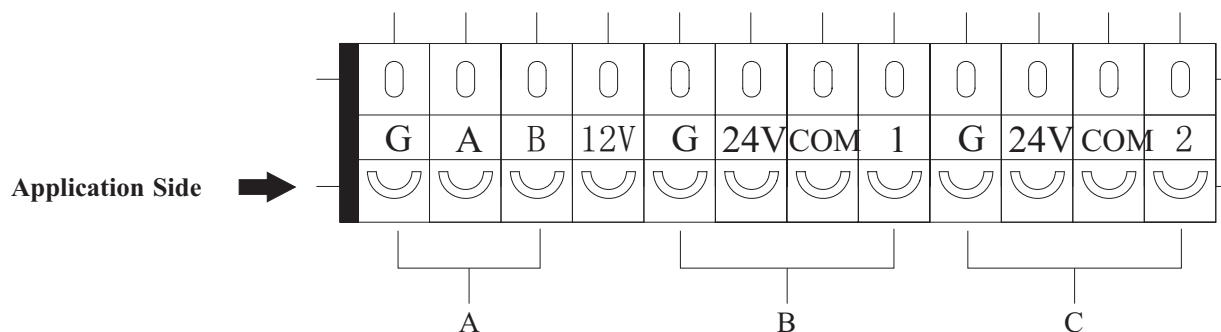

#### **A: Signal cable to monoblock unit**

Please connect A and B together with A and B on monoblock unit.

#### **B,C: Motorized Water mixture valve 1&2:**

As explained in System illustration chapters, this unit can have two water mixture valves for distribution system under its control.

Water Mixture Valve 1 for Heating & Cooling circuit 1

Water Mixture Valve 2 for Heating & Cooling circuit 2

## 3. Installation

### 4) Terminal block 4

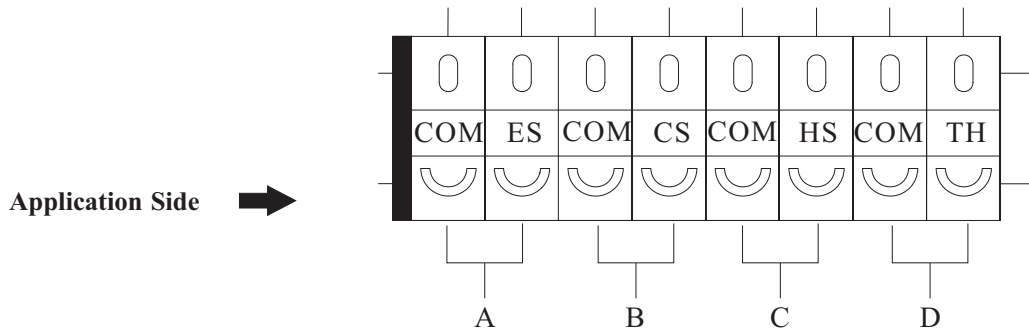

#### D: Electrical Utility Lock Input

Some electricity companies offer a special rate if the house power consumption is lowered to a certain value during peak time. If the unit is supposed to stop working during this period, one can connect the signal from electricity company to this “External Shutdown” port and use the parameter setting to activate this function.

#### E, F: Cool mode & heat mode switch-over

This unit can switch over between heating and cooling functions automatically, according to ambient temperature, or external signal input.

For ambient temperature switching, please refer to part 1.06 of introduction of user’s interface for detailed setting.

For external signal input, external signal should be connected to “COOL MODE SWITCH” for cooling operation, and “HEAT MODE SWITCH” for heating operation.

#### G: High demanding distribution system switch

- ◆ When two heating distribution systems are connected, unit should always take the set temperature for high demanding circuit, which needs higher temperature in heating and lower temperature in cooling operation, as the set temperature for the heat pump unit.
- ◆ However, when this high demanding circuit is not needed or has reached the set temperature, heat pump unit can switch the heat pump set temperature to the values set for the other circuit, for better efficiency.
- ◆ This set of connector is used to receive the signal from high demanding circuit, if has.
- ◆ When "CLOSE" signal is received, unit works with high demanding.  
When "OPEN" signal is received, unit works with low demanding.

# 3. Installation

## 3.6.2 Wiring

- ◆ It is recommended to use a suitable circuit breaker for the heat pump;
- ◆ The power supply to the heat pump unit must be grounded.
- ◆ The wiring should be done by professional person.
- ◆ The wiring should be comply with the local industry regulation.
- ◆ The wiring should be done after the unit is powered off.
- ◆ Cable should be fixed tightly, to ensure it won't get loose.
- ◆ Don't connect several parts of cables together to use.
- ◆ Make sure the power supply in the local coincide with the power supply marked in rating label.
- ◆ Make sure power supply, cable and socket can meet the requirement of the input power of the unit.



### Installation sketch

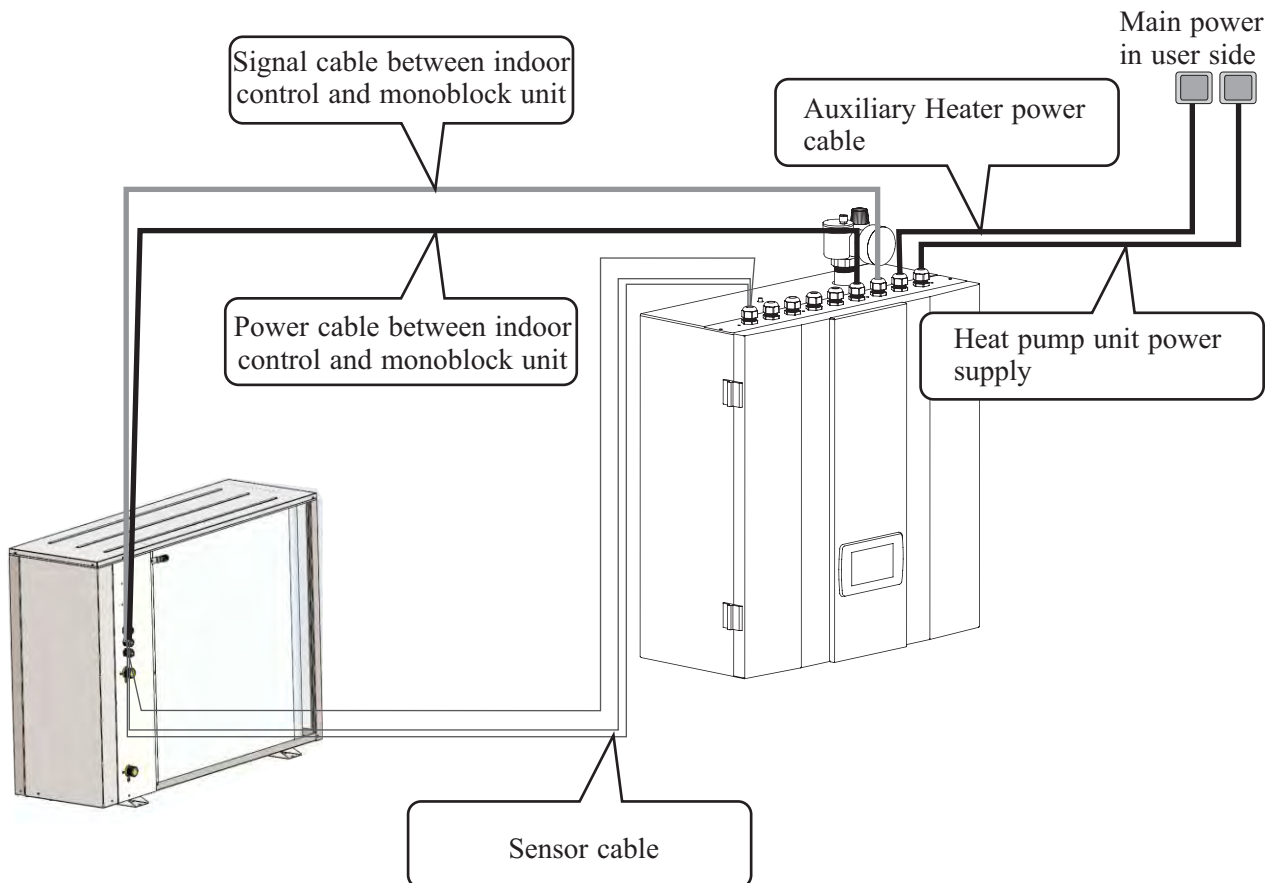



### 3. Installation

Before wiring, open the indoor control unit front panel and take off the electronic box cover.

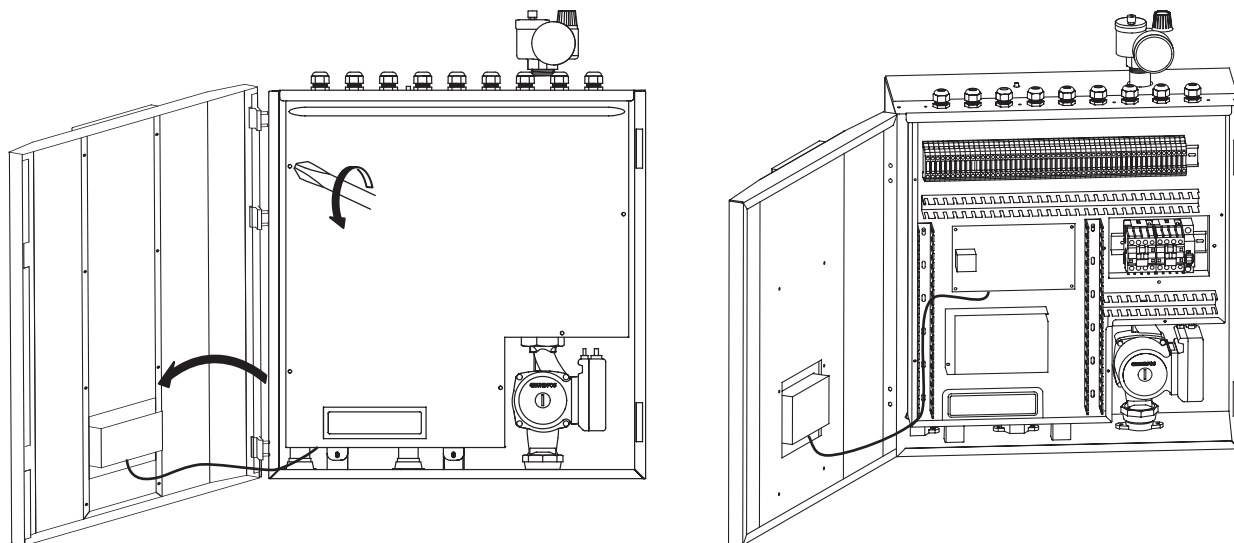

#### 1) Heat pump unit power supply

Get a power cable in suitable length that complies to the local safety regulations.

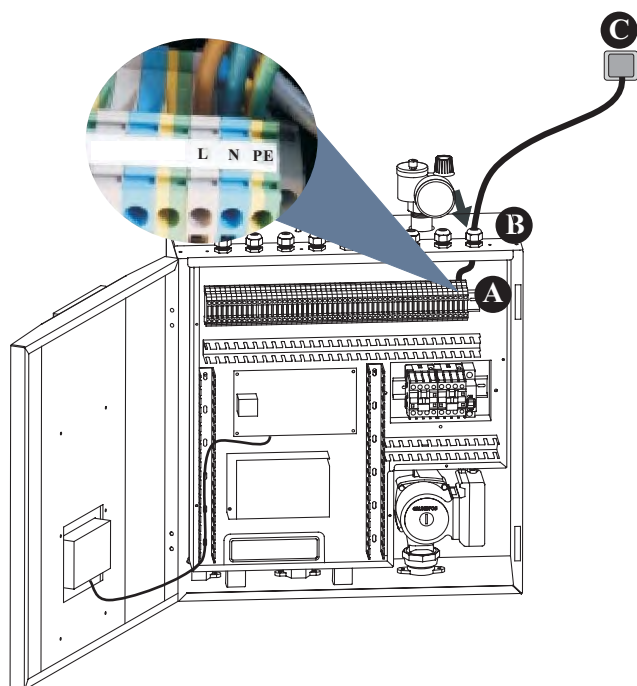

A. Insert one end of this cable through the cable gland on bottom of the indoor control unit, and connect it with heat pump power supply terminals (PE, N, L).

B. Fasten the cable gland to ensure the cable won't get loosen.

C. Connect the other end to the city power supply.

## 3. Installation

### 2) Auxiliary Heater power cable

Get a power cable in suitable length that complies to the local safety regulations.

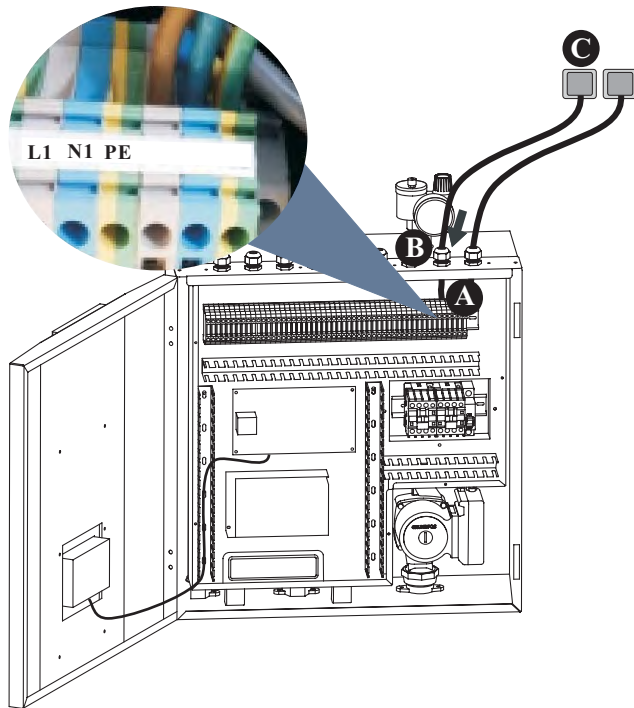

- A. Insert one end of this cable through the cable gland on bottom of the indoor control unit, and connect it with AH power supply terminals (PE, N1, L1).
- B. Fasten the cable gland to ensure the cable won't get loosen.
- C. Connect the other end to the city power supply.

### 3. Installation

#### 3) Signal cable between indoor control unit and monoblock unit

10M communication cable is packed in accessories bag.

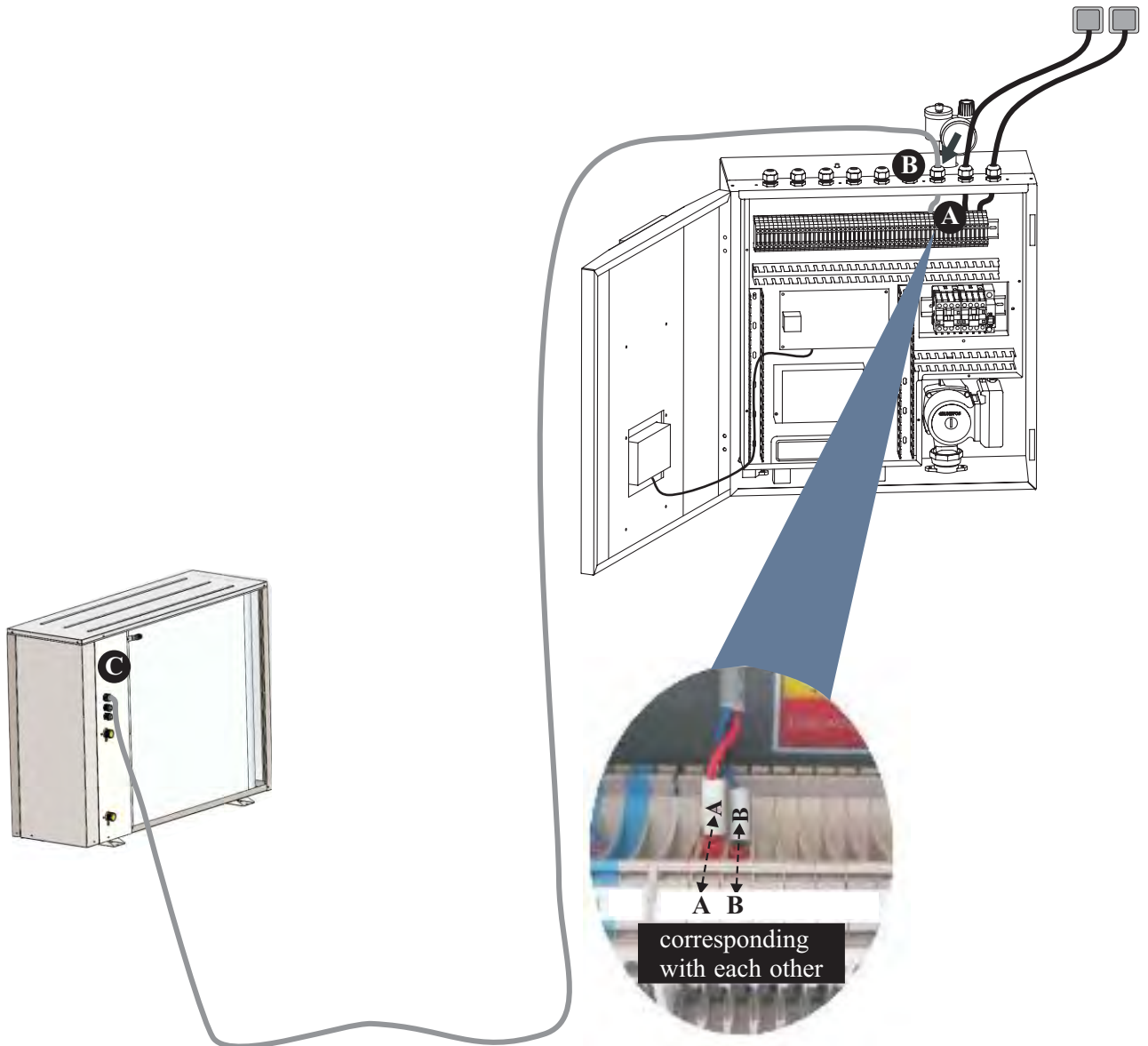

A. Insert one end of this cable through the cable gland on bottom of the indoor control unit, and connect this cable to A and B on terminal block.

B. Fasten the cable gland to ensure the cable won't get loosen.

C. Take off the top cover , and connect the other end of communication cable to correspondent terminal block through cable gland. Fix the cable with cable gland after cable is well connected. A and B on monoblock unit should be connected with A and B on indoor control unit, otherwise unit will show communication failure.

### 3. Installation

#### 4.1) Power cable between indoor control unit and monoblock unit

Prepare a 3 cores power cable with suitable length that complies the local safety regulations,

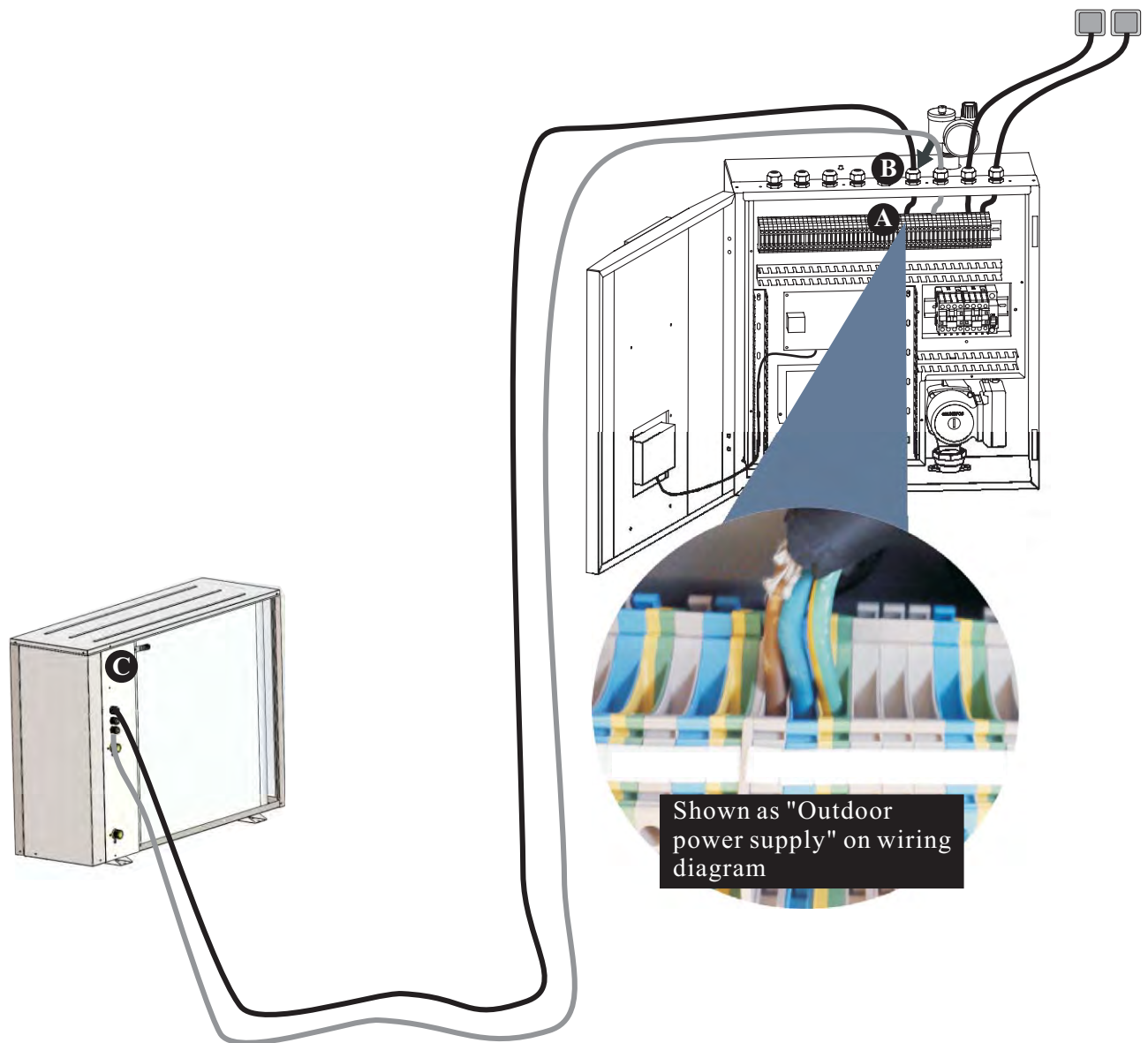

A. Insert one end of this cable through the cable gland on bottom of the indoor control unit, and connect this power cable to "Outdoor power supply" on indoor control unit terminal block.

B. Fasten the cable gland to ensure the cable won't get loosen.

C. Connect cable between indoor control unit and monoblock unit to correspondent terminal block according to the wiring diagram. Fasten the cable gland to ensure the cable won't get loosen.

When connecting the power cable between the monoblock unit and indoor control unit, cables connected to the terminal block in indoor control unit must match these in monoblock unit. For example, if the terminals and power cables are connected as  $\oplus$  → gree/yellow cable, L → red cable, N → blue cable, S → black cable in indoor control unit, the connections in the monoblock unit should be in the same way.

# 3. Installation

## 5) Sensor cables

Take all sensors and communication cables out from the accessories bag. Connect the sensors together with the quick connectors on communication cables and insert the end with the connector into the indoor unit through cable gland. Connect them with the quick connector inside the indoor unit and place all sensors in right positions. Fasten the cable gland after installations.

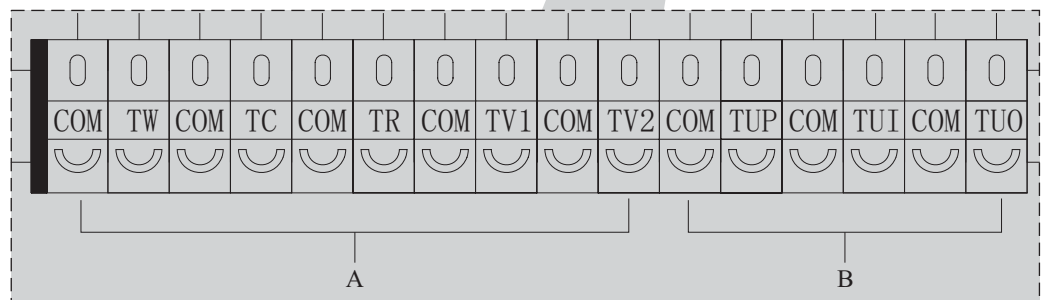
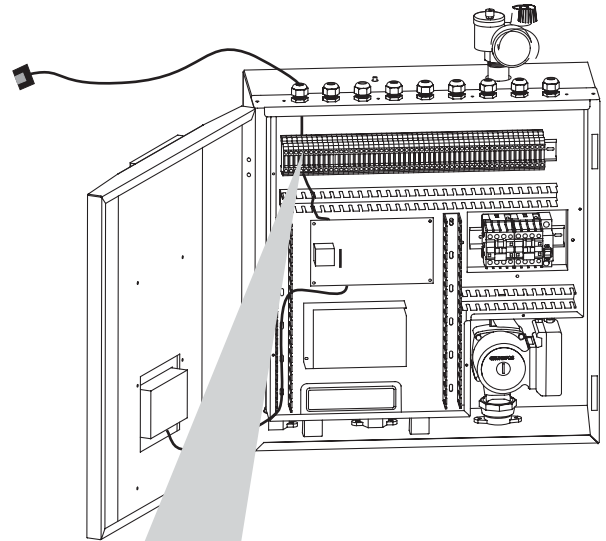
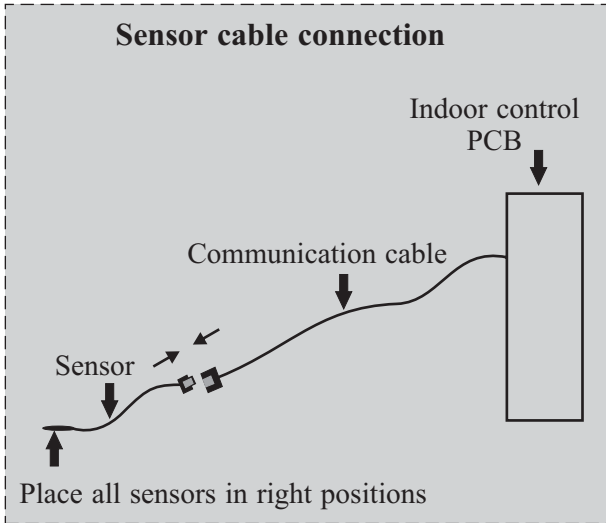

|   |   |  |
|---|---|--|
| A | TW-Water temperature sensor for sanitary hot water  | Connect these sensors with communication cables by quick connector, and then connect communication cable (the end without quick connector) with terminal block. (These sensors are packed inside the accessories bag).   |
|   | TC-Water temperature sensor for cooling and heating |  |
|   | TR-Room temperature sensor                          |  |
|   | TV1-Water temperature sensor after mixture valve 1  |  |
|   | TV2-Water temperature sensor after mixture valve 2  |  |
| B | TUP-Coil temperature sensor                         | Connect these sensors with communication cables by quick connector, and then connect communication cable (the end without quick connector) with terminal block. (These sensors are installed already, but should be connected to terminal block inside indoor control box via communication cables). |
|   | TUI-Water inlet temperature sensor                  |  |
|   | TUO-Water outlet temperature sensor                 |  |

### 3. Installation

Install the electric box cover on indoor control unit and electric box cover on monoblock unit back, and close the door of indoor control unit.

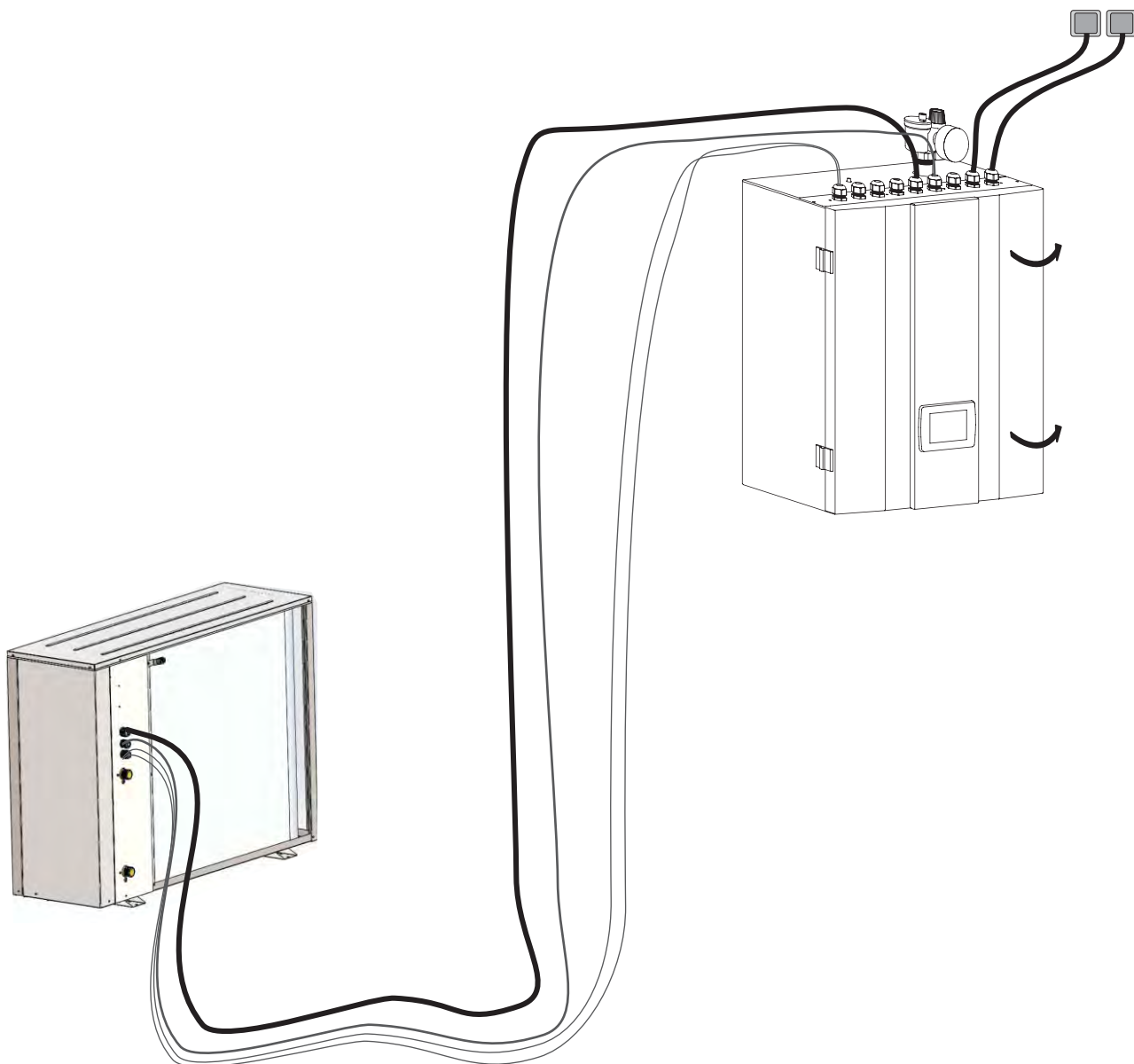

## 3. Installation

### 3.7 Installation of safety valve kit

1) Install the safety valve kit to the connector on top of indoor control unit.

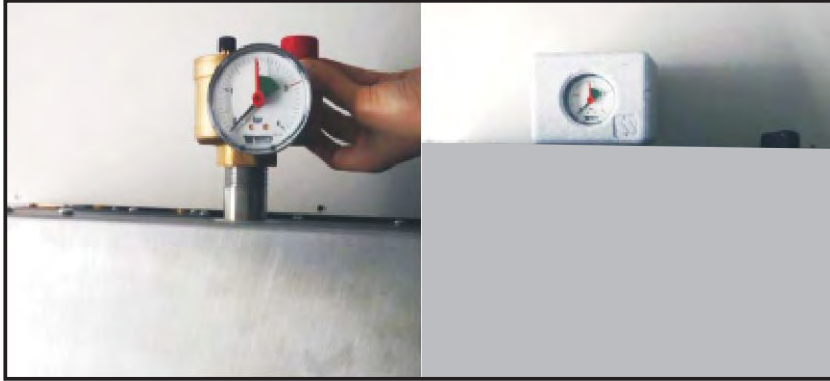

2) Connect the drainage pipe to safety valve outlet.



3) Have the drainage pipe out from the hole on the bottom by going through the unit.

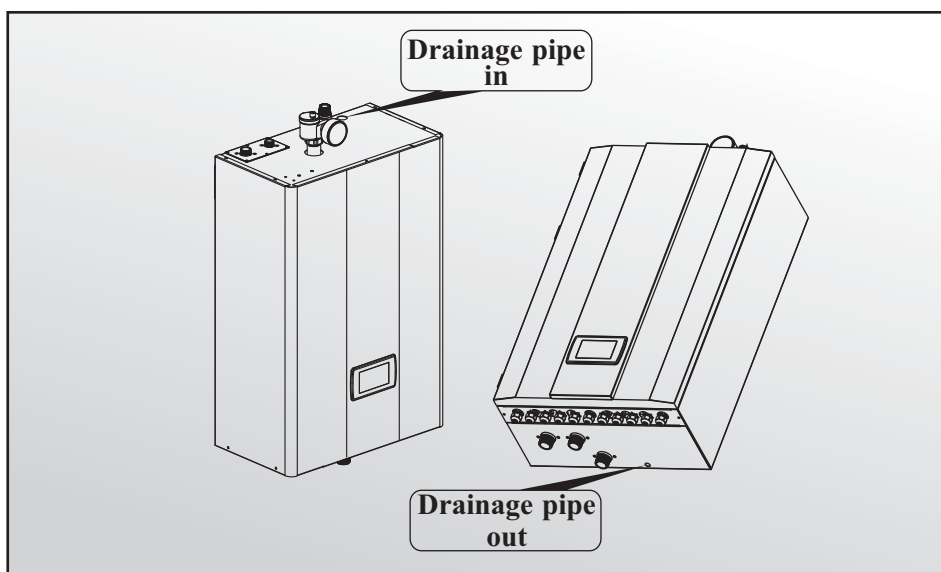

## 3. Installation

### 3.8 Water pipe connection

After installing the unit, please connect the water inlet and outlet pipe according to the local regulations. Please carefully select and operate the water pipe. After connection, the water piping should be pressure tested, cleaned before use.

#### 1) Filter

A mesh filter must be installed in front of the water inlet of the unit and water tank, to keep the water quality and collect impurity contained in the water. Take care to keep the water filter mesh towards the bottom. Check valve is recommended to be installed at both sides of the filter, so as to clean or change the filter in a easier way.

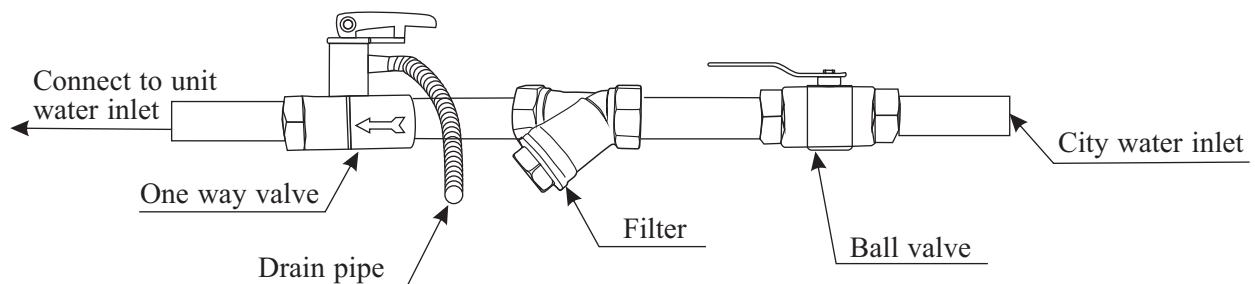

#### 2) Insulation

All pipes running hot water should be well insulated. The insulation must be tied up tightly without gap (But please don't wrap up the check valve for future maintenance).



Please ensure enough water pressure to send the water to the required height. If the water pressure is not enough to maintain proper water flow rate for the system, please add a water pump to increase the pumping head.

#### 3) Requirements of water quality

- A. Chloridion element in the water should be less than 300ppm(temperature is less than 60°C).
- B. PH value of water should be from 6 to 8.
- C. The water with ammonia can't be used for the unit.

If the water quality is bad, or water flow too little, scale formation or clogging may happen after unit running for a long time, then the efficiency of cooling or heating will be low or the unit will work abnormally.

Please clean water before use, or use purified water. Make sure the water quality is good enough to keep the unit long-term running in high efficiency.



## 3. Installation

### 3.9 Test run



**After installation finished, please fulfill the water system with water and purge out air in the system before start-up.**

#### 1) Before start-up

Before the unit starts up, a certain number of verifications must be performed on the installation to ensure that the unit will operate under the best possible conditions. The check list below is not exhaustive and should only be used as a minimum reference basis:

- A. Make sure fan rotates freely;
- B. Inspect all water piping for flow direction;
- C. Verify all system piping is correct for operation as per installation requirements;
- D. Check voltage of the unit power supply and make certain voltage is within authorized limitations;
- E. Make sure the unit is properly grounded;
- F. Check the presence of protective and breaking devices;
- G. Check all electric connections for tightness.
- H. Check all piping for leaks and air is well ventilated.



**If everything above is OK, the unit can start up.  
If any of them fails, please fix it.**

#### 2) Pre-start up

- A. When the installation of unit is completed, water system pipes are well connected and air purging is done, no leakage or other problems, the unit can be powered to start up.
- B. Turn on the unit, press the on-off button on the operation panel to start the unit. Please check carefully if there is some abnormal noise or vibration, or the display of wired controller is normal or not.
- C. After the unit is working properly for 10 minutes, without any problem, then the pre-start up is completed; If not, please refer to the Service and Maintenance chapter in this manual to solve the problems.



**It is suggested not to run "heating" or "hot water" mode, when ambient temperature is over 32 °C, otherwise unit may go into protection mode easily.**

# 4. Usage

## 4.1 Introduction of operation panel

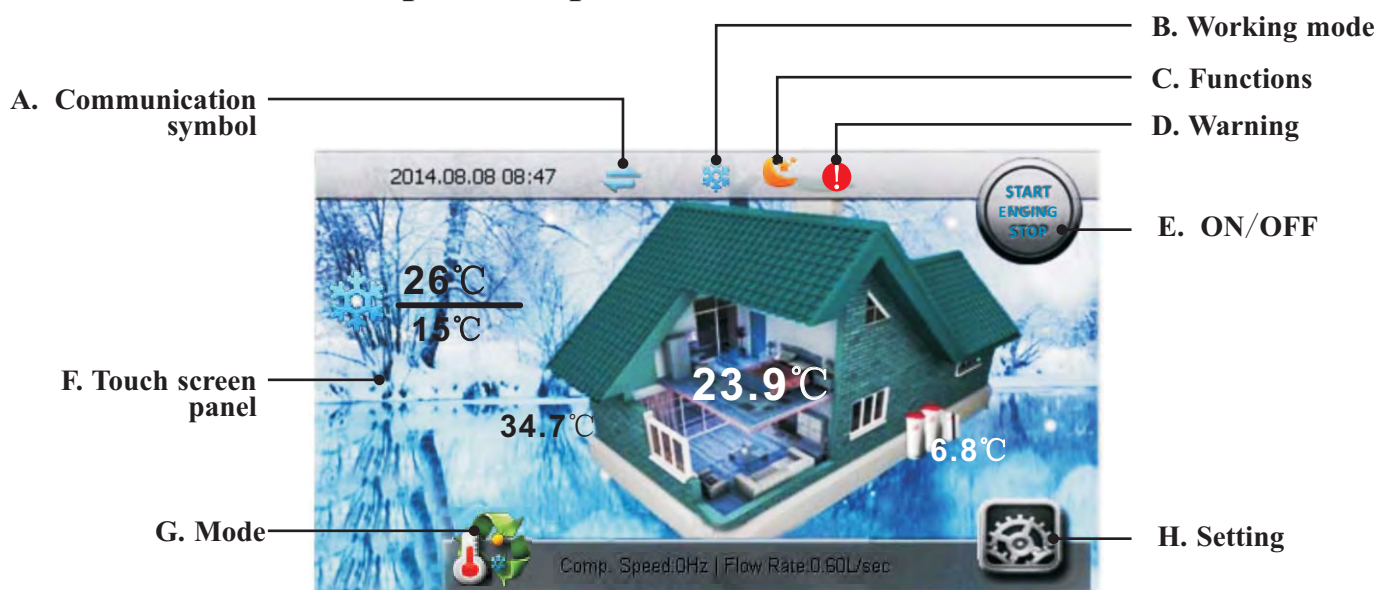



### A. Communication symbol







When this symbol is in blue, it means communication is working correctly.  
When this symbol is grey, it means communication is broken.

### B. Working mode

Working mode switching symbol is ON when system working mode is under switching. If more than one working mode are activated at the same time, correspondents working mode symbol will be shown on the display.

|   |                |
|---|----------------|
|  | Heating mode   |
|  | Cooling mode   |
|  | Hot water mode |



### C. Functions

|   |                                 |
|---|---------------------------------|
|  | Sleep mode                      |
|  | Interruption                    |
|  | Sanitary hot water storage mode |
|  | Preheating mode                 |
|  | Sanitization mode               |
|  | Defrosting mode                 |

## 4. Usage

### D. Warning

When the unit is having a protection or failure, a symbol will be shown on the display. Please enters into "Info" menu to check the protection or failure codes.

|   |  |
|---|--|
|  | Yellow——Outdoor unit protection or failure |
|  | Red——System protection or failure          |

Some information, protections and failures that are more likely to happen, will shown in front page so the customer can see it easier:



#### 1. Coil Temp. too low

This is indoor coil temperature too low. This happens in cooling operation of the unit. Too low coil temperature may make the water freeze up inside plate heat exchanger and cause damage. Compressor speed down if coil temp. lower than 2°C ; Compressor stops if coil Temp. lower than -1°C ; Compressor restarts if coil Temp. higher than 6°C. When this happens, please:

- A. Check whether set temperature for cooling is too low; whether system has too small water flow rate; check water system especially the filter.
- B. Check whether system has not enough refrigerant inside by measuring the evaporating pressure.
- C. Check whether ambient temperature is lower than 15°C.

#### 2. Water flow rate too small

System water flow rate is less than minimum allowable flow rate. Check the water system, especially the filter; check the working statue of water pump.

#### 3. Water flow switch failure

Water flow switch should be in open mode when unit circulation pump is working. If not, the unit think the flow switch itself is broken. Check whether flow switch is broken or not well connected. Check whether there has another pump that circulates the water through the unit, when unit circulation pump is working.

#### 4. Communication Failure!

Communication failure shown here means the communication between operation panel, indoor PCB and outdoor PCB have been set up, but communication data lost too much. Check whether communication cable is longer than 30M; whether there has a source of the disturbance nearby the unit. Unit recovers when communication recovers.

## 4. Usage

### 5. Serial port connect error

Serial port connect error means the communication between operation panel and indoor PCB or outdoor PCB hasn't been set up successfully. Check the cable connection in between. Check whether the last three switches on outdoor power PCB are set to 001; whether last three switches on indoor PCB are set to 001. Unit recovers when communication recovers.

### 6. Cooling water Temp. too low

Compressor stops if water outlet is lower than 5°C in cooling mode. This too low water temperature may make the water freeze up inside plate heat exchanger and cause damage. Check whether temperature sensor Tc is OK and well connected; whether set water temperature too low; whether system flow rate too small.

### 7. Water outlet Temp. too high

Compressor stops if water outlet is higher than 57°C in heating or hot water mode. This too high water temperature may make the system has too high condensate pressure inside and cause unit malfunction. Check whether temperature sensor Tc and Tw is OK and well connected; whether set water temperature too high; whether system flow rate too small.

### 8. Defrosting Failure

If unit continuously failed to finish the defrosting operation for three times, it stops and gives failure code S08. This can only be recovered by re-powering the machine. Please check whether the actual water temperature is too low for the unit to defrost, so the plate heat exchanger has the risk of freezing up.

### 9. Water outlet Temp. too low

This is also used to protect the safety of the compressor. Compressor stops and AH (or HBH) starts if water outlet temperature is lower than 15°C in heating and hot water mode. Compressor restarts when this temperature is higher than 17°C.

### 10. Too small water flow rate failure

If unit stops due to “too small water flow rate” protection (S02) over three times in certain period of time, unit stops and gives S10 failure code. It can only be recovered by re-powering the unit. Check the water system, especially the filter; check the working statue of water pump.

### 11. Indoor anti-freezing protection failure in cooling

If unit stops due to “Indoor anti-freezing protection in cooling (S01)” over three times in certain period of time, unit stops and gives S11 failure code. It can only be recovered by re-powering the unit.

## E. ON/OFF

Press to turn ON/OFF of heat pump operation.

When the unit is powered, home page will be shown on the screen. After repowered, unit will recover its working mode and settings automatically.

## 4. Usage



### F. Touch screen panel



### G. Mode

Press to switch unit working mode (Heating, Cooling, Hot water, Auto). In Auto mode, unit switch its working mode between cooling, heating and sanitary hot water automatically according to setting.



# 4. Usage

## H. Setting: Press to enter into setting menu.

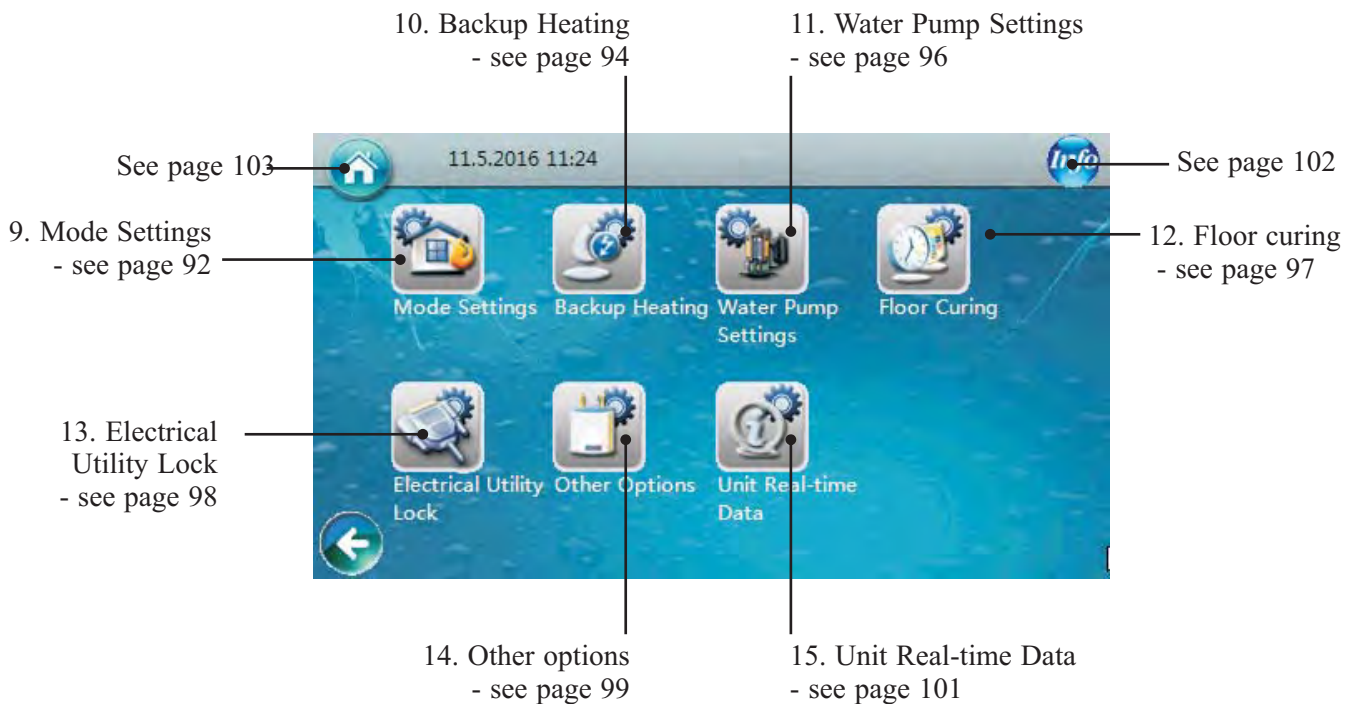

# 4. Usage

## 4.2 Operation Instruction

### 1. Heating/Cooling circuit 1

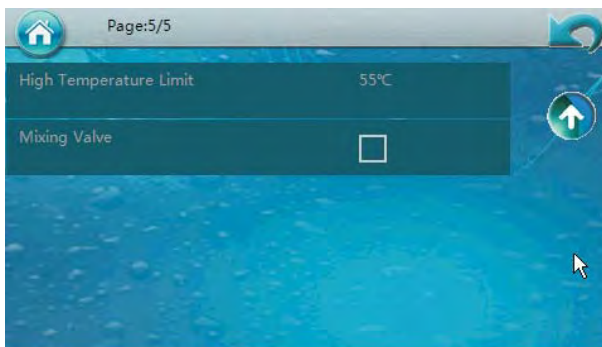
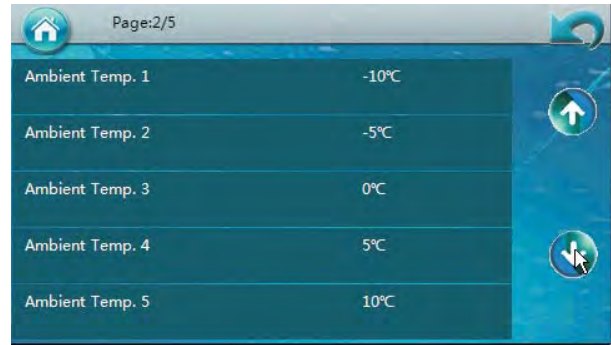

#### 1. Heating & Cooling Settings 1, HC/CC 1

1.01) Heating or Cooling Stops based on Water  $\Delta T$

1.02) Heating or Cooling Restarts based on Water  $\Delta T$

- ◆ 1.01: This is to set a temperature to stop unit. Unit stops operation when  $[T_{set} + 1.01]$  in heating operation, or  $[T_{set} - 1.01]$  in cooling operation is reached.
- ◆ 1.02: This is to set a temperature to re-start unit. Unit starts operation again when water temp. drops below  $[T_{set} - 1.02]$  in heating operation or increases over  $[T_{set} + 1.02]$  in cooling operation.
- ◆ Both the set values are based on  $\Delta T$ .
- ◆ For example, in heating mode, if  $T_{set} = 48$ , while  $1.01 = 2^\circ C$ , and  $1.02 = 1^\circ C$ , when actual water temperature is higher than  $50^\circ C$  ( $T_{set} + 1.01$ ), unit stops. When unit stops and actual water temperature drops lower than  $47$  [ $T_{set} - 1.02$ ], unit restarts.

## 4. Usage

### 1.03 $\Delta T$ Compressor Speed-Reduction

This parameter is used to set a temperature, at which compressor starts to slow down its speed. Also, the set value is based on  $\Delta T$ .

Compressor always works with its maximum allowable speed, if actual water temperature is lower than  $[T_{set}-1.03]$  (in heating mode) or higher than  $[T_{set}+1.03]$  (in cooling mode).

When actual temperature is between  $[T_{set}-1.03, T_{set}]$  in heating mode or  $[T_{set}, T_{set}+1.03]$  in cooling mode, compressor will adjust its working speed, to balance the total heating output and system heating load.

This setting is to keep a balance between comfort and energy saving. If this value is set too big, even if the room is not warm (or cool) enough, compressor will slow down its speed quite soon to save energy; If this value is set too small, even if the room is warm (or cool) enough, compressor will slow down its speed quite late, which consumes more power.

It's more like a setting that tells the heat pump unit which temperature range you'd prefer to have the heat pump stayed in.

For example, in heating mode, if  $T_{set}=48$ , and  $1.03=2^{\circ}\text{C}$ , compressor will work as hard as possible to get  $46^{\circ}\text{C}$  as soon as possible. Then compressor will lower its speed. If even the compressor works in its lowest allowable speed, but actual water temperature still goes over  $[T_{set}+1.01]$ , unit stops.

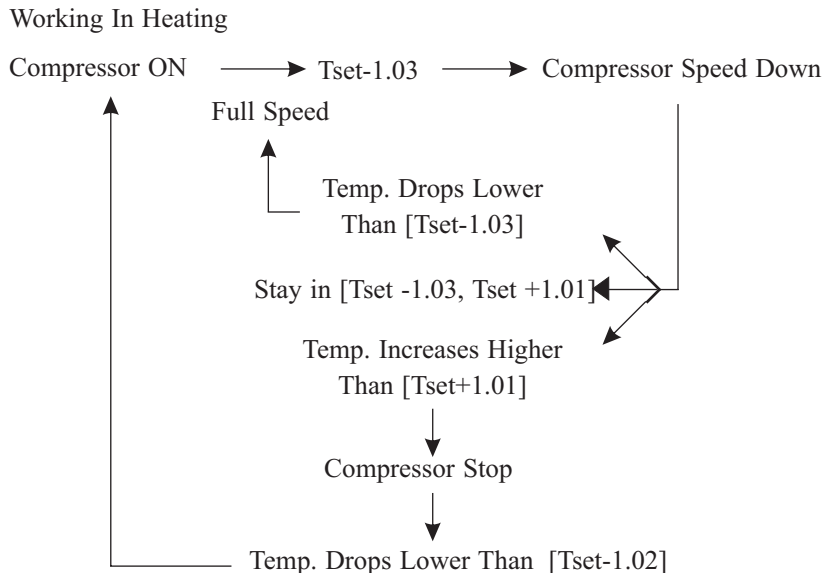

### 1.04) Set Temp for Cooling

Set an ideal water temperature for cooling via this parameter.

### 1.05) Heating Curve Function

Set whether heating curve function is needed or not.

If heating curve function is not needed, set 1.05=OFF, and then you can set a fixed water set temperature under heating mode via parameter 1.19 "Set Temp For Heating"

### 1.06~1.15 Set the heating curve

#### 1.06 Ambient Temp. 1

#### 1.07 Ambient Temp. 2

#### 1.08 Ambient Temp. 3

#### 1.09 Ambient Temp. 4

#### 1.10 Ambient Temp. 5

#### 1.11 Water Temp. A/Ambient Temp. 1

#### 1.12 Water Temp. B/Ambient Temp. 2

#### 1.13 Water Temp. C/Ambient Temp. 3

#### 1.14 Water Temp. D/Ambient Temp. 4

#### 1.15 Water Temp. E/Ambient Temp. 5

When 1.05=ON, user can set a heating curve which fits his house, by adjusting the settings of parameter 1.06~1.05



## 4. Usage

Parameter 1.06~1.10 is used to set 5 different ambient temperatures; while parameter 1.11~1.15 is used to set 5 corresponding set water temperatures VS these 5 ambient temperatures. Then the controller will create a heating curve according to these settings, and try to reach the set water temperature automatically according to actual ambient temperature.

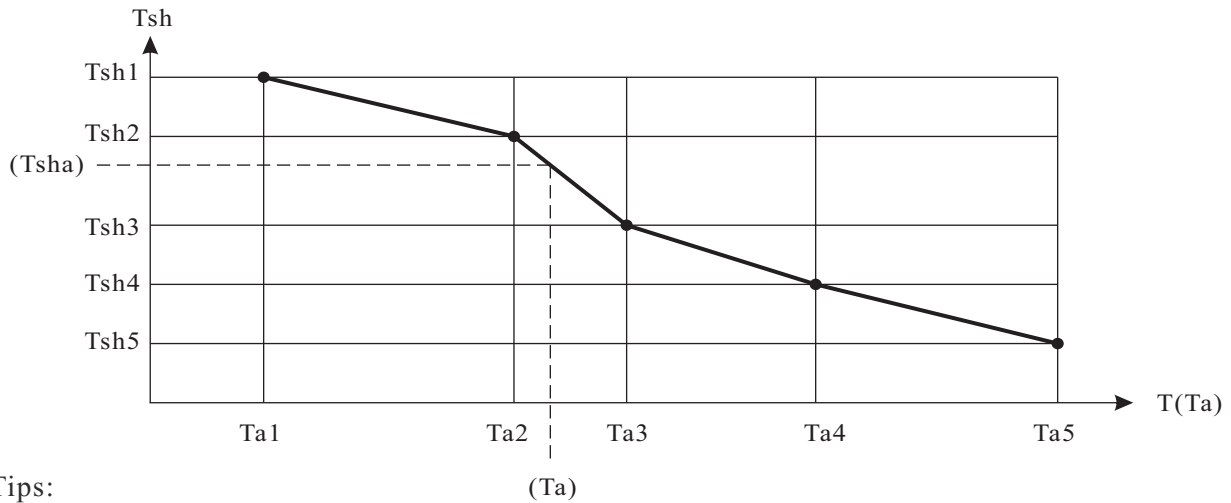

Tips:

Heating curve function is based on the factor that the lower the ambient, the higher house heating water temperature needs to be. This heating curve function can help the heat pump unit gain a higher COP, as well as make the house more comfortable.

As house insulation level and people's sense of cold may vary from one another, the factory-set curve may not suit you the best. You can set one curve according to your need.

If you feel too hot, you can lower the settings of water temperatures (parameter 1.11~1.15), which correspond to the ambient temperature parameters (1.06~1.10). If you feel too cold, then adjust these settings a little higher. You can also adjust the ambient temperature settings, if you think the factory settings are not perfect for your need.

### 1.16~1.18) Water Temp. Setting Adjustment function

These three parameters work together to gain an ideal water temperature for an ideal room temperature. When this function is ON, unit will adjust the set water temperature (a set value or calculated value via heating curve), according to the difference between actual room temperature and ideal room temperature.

**1.16 Room temp. effect on Heating Curve: Turn ON or OFF this function.**

**1.17 Ideal Room temp. in Heating: Set an ideal room temperature in heating.** When in Room Temperature Control mode, this parameter will also be the Room Set Temperature.

**1.18 Ideal Room temp. in Cooling: Set an ideal room temperature in cooling.** When in Room Temperature Control mode, this parameter will also be the Room Set Temperature.

For example

If 1.16 = ON, unit works in heating mode.

If water set temperature in the heating curve is 35°C.

If actual room temperature is 27°C, while parameter 1.17 (Ideal Room Temp. in Heating Mode) is set to 22°C, then the unit will deduct  $(27^\circ\text{C} - 22^\circ\text{C}) = 5^\circ\text{C}$  from water set temperature, which means unit will take 30°C as the set water temperature.

### 1.19 Set Temp For Heating

If heating curve function is OFF, a fixed water temperature for heating can be set via "Set Temp For Heating".

### 1.20 Low Temperature Limit

### 1.21 High Temperature Limit

These two parameters are used by the installer, to set the set temperature range for circuit 1 for safety purpose.

### 1.22) Mixing Valve

Set whether circuit 1 has a mixing valve connected or not. For more details, please refer to chapter 2.1.4.

# 4. Usage

## 2.Heating / Cooling circuit 2



|   |                          |
|---|--------------------------|
| Heatingcooling Circuit 2                      | <input type="checkbox"/> |
| Set temp. For Cooling                         | 15°C                     |
| Set Temp. for Heating (without heating curve) | 35°C                     |
| Mixing Valve                                  | <input type="checkbox"/> |
| Heating Curve                                 | <input type="checkbox"/> |

|                               |      |
|-------------------------------|------|
| Water Temp. A/Ambient Temp. 1 | 38°C |
| Water Temp. B/Ambient Temp. 2 | 35°C |
| Water Temp. C/Ambient Temp. 3 | 32°C |
| Water Temp. D/Ambient Temp. 4 | 30°C |
| Water Temp. E/Ambient Temp. 5 | 30°C |

|                        |      |
|------------------------|------|
| High Temperature Limit | 55°C |
| Low Temperature Limit  | 7°C  |

### 2.01 Heating&cooling Circuit 2

Set whether the system has the second circuit .

### 2.02 Set Temp For Cooling

Set the set temperature for cooling operation of circuit 2.

### 2.03 Set Temp For Heating

If heating curve function is disabled for circuit 2, a fixed value of set water temperature in heating mode can be set here.

### 2.04 With/Without Mixing Valve 2

Set whether circuit2 has a mixing valve connected. For more details, please refers to chapter 2.1.5

### 2.05 Heating Curve

Turns ON/OFF of heating curve function for circuit 2.

### 2.06 Water Temp. A/Ambient Temp. 1

### 2.07 Water Temp. B/Ambient Temp. 2

### 2.08 Water Temp. C/Ambient Temp. 3

### 2.09 Water Temp. D/Ambient Temp. 4

### 2.10 Water Temp. E/Ambient Temp. 5

Temperature set here is water temperature, it is based on the same ambient temperature settings for circuit 1, parameters 1.06~1.10.

Temperature settings of the heating operation for circuit 2 VS ambient temperatures. Controller will create a heating curve for secondary heating system according to these settings. If parameter 2.05 is OFF, only 2.03 needs setting, and unit will take this set value as fixed set water temperature for secondary heating system.

### 2.11 High Temperature Limit

### 2.12 Low Temperature Limit

These two parameters are used by the installer, to set the set temperature range for circuit 2 for safety purpose.

# 4. Usage

## 3. DHW Settings



|   |                          |
|---|--------------------------|
| Setpoint DHW                            | 50°C                     |
| DHW Restart $\Delta T$ Setting          | 5°C                      |
| Shifting Priority                       | <input type="checkbox"/> |
| Shifting Priority Starting Temp.        | 15°C                     |
| Sanitary Water Min. Working Hours       | 30Min                    |
| Heating Max. Working Hours              | 90Min                    |
| Allowable temp Drift in Heating         | 6°C                      |
| DHW Backup Heater for Shifting Priority | <input type="checkbox"/> |

### 3.01 Setpoint DHW

Set temperature for sanitary hot water.

### 3.02 DHW Restart $\Delta T$ Setting

Heat pump unit will start working for sanitary hot water again, after temperature drops below  $T_{set}-3.02$  here.

### 3.03 Shifting Priority

Turn ON/OFF this function.

Air to water heat pump is an equipment that absorbs heat from surrounding air, and transfers it to water. The lower the ambient temperature is, the less heat the unit absorbs. This makes the unit heating capacity and efficiency drop when ambient temperature drops. The unit takes longer time to heat up the sanitary hot water. However, the lower the ambient temperature is, the more heat the house demands. If the unit does not provide enough heat while it is working for hot water, the temperature inside the house may drop too much, and people in it feel uncomfortable. So parameters 3.03~3.08 try to divide the working time for sanitary hot water into several cycles, after ambient temperature drops below a set value. When this function is ON, AH (Auxiliary Heater) or HWTBH (Hot Water Tank Back-up Heater) or both, depending on their priority, will work individually or together to enhance heat pump's capacity in sanitary hot water mode to heat up the water as soon as possible.

### 3.04 Shifting Priority Starting Temp.

Set an ambient temperature below which this function starts to work. When shifting priority function is activated, heat pump will try to find a balance between DHW and Heating operation after ambient temperature drops below this temperature.

### 3.05 Sanitary Water Min. Working Hours

Set the minimum working period for sanitary hot water mode.

### 3.06 Heating Max. Working Hours

Set the maximum working period for heating mode, after unit enters into heating mode.

### 3.07 Allowable Temp Drift in Heating

Set allowable temperature drift in heating mode.

### 3.08 DHW Backup Heater for Shifting Priority

Working mode of HWTBH (Hot Water Tank Back-up Heater) in this function. If this parameter is set ON, when heat pump is switching to house heating, HWTBH will keep on working to help the unit heat up hot water as soon as possible.

## 4. Usage

If shifting priority function is ON, and ambient temperature is lower than [3.04], unit works as shown below:

House heating water under water temp.

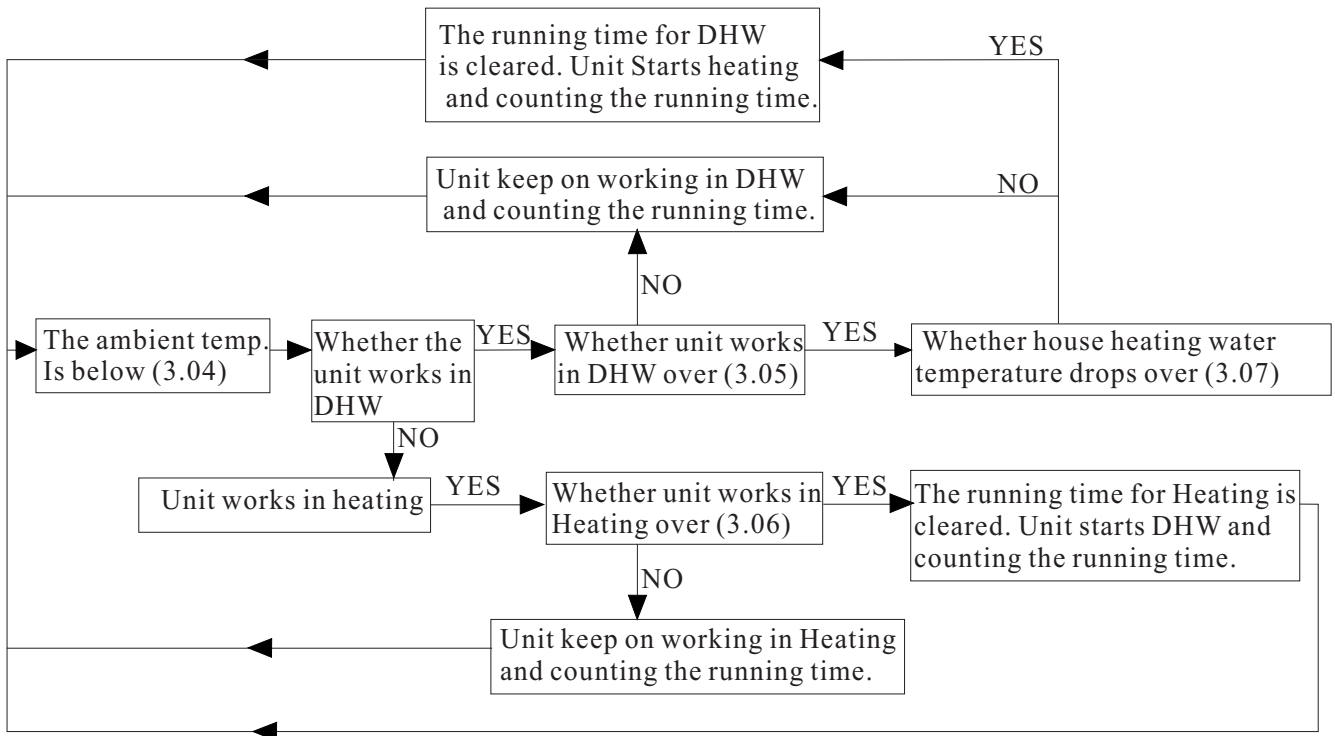

# 4. Usage

## 4.DHW Storage



|                                     |                          |
|-------------------------------------|--------------------------|
| Sanitary Hot Water Storage Function | <input type="checkbox"/> |
| Sanitary Hot Water Storage Timer    |                          |
| Reheating Function                  | <input type="checkbox"/> |
| Reheating Function Timer            |                          |
| Reheating Set Temp.                 | 35°C                     |
| Reheating Restart ΔT Setting        | 10°C                     |

### Sanitary Hot Water Storage Function

After showers, house usually needs only medium temperature sanitary hot water in day time. This function is used to store high temperature sanitary hot water in low demand time (mid-night, or day time of working days), and reheat the water to medium temperature out of this time period.

#### 4.01 Sanitary Hot Water Storage Function

Turn ON/OFF this function.

#### 4.02 Sanitary Hot Water Storage Timer

Set a working time period for this function, and the unit starts to work towards sanitary hot water set temperature in parameter 3.01 within the set time range. Different time periods for every day in a week can be set.



#### 4.03 Reheating Function

Turn ON/OFF reheat function.

#### 4.04 Reheating Function Timer

Set a working time period for reheat function, and within this time period, unit will work with a lower set value for DHW (value set in parameter 4.05). Different time periods for every day in a week can be set.

## 4. Usage

---

### **4.05 Reheating Set Temp.**

Set a lower set value for DHW operation. Unit will work with this set value when reheating function is activated in the set time period (time period set in parameter 4.04).

### **4.06 Reheating Restart $\Delta T$ Setting**

Set “reheat restart” water  $\Delta T$ . When water temperature drops below  $\Delta T$  based on reheat set temperature within the set reheating time period, unit restarts.

## 4. Usage

### 5. Reduced Setpoint for Heating



**Reduced Setpoint Function:** Sometimes the house heating demand maybe lower than normal, like during sleep period or working time. In this way, a reduced value based on standard set value can be set here for better efficiency of the whole system.

**Quiet Operation:** Also, for a better noise issue, a Quiet Operation can be also set in this menu. After activating this function and setting the time period for quiet operation, unit will try to reduce its noise level.

Note: Unit efficiency in quiet operation mode will be lower than standard working mode.

#### 5.01 Reduced Setpoint

Turn ON/OFF Reduced Setpoint function.

#### 5.02 Temp. Drop/Rise

Set temperature drop (in heating) or increase (in cooling) based on standard set temperature during Reduced Setpoint operation.

#### 5.03 Timer for Reduced Setpoint Function

Set a working time period for Reduced Setpoint function.  
Different time periods for every day in a week can be set.

#### 5.04 Quiet Operation

Turn ON/OFF Quiet Operation function.

#### 5.05 Allowable Temp. Drifting

Set allowable temperature drift during Quiet Operation.

When the unit works in quiet mode, its output may drop because both fan and compressor may need to work in lower speed. However, temperature in the system may drop (in heating) or increase (in cooling) too much due to the lower output. So when actual temperature drift from the standard set value is more than the  $\Delta T$  set value here, unit will end this quiet operation, to ensure comfortable house temperature.

#### 5.06 Timer for Quiet Operation

Set a working time period for Reduced Setpoint function  
Different time periods for every day in a week can be set.

## 4. Usage

### 6. Anti-Legionella Function



|                         |                          |
|-------------------------|--------------------------|
| Anti-Legionella Program | <input type="checkbox"/> |
| Day and Time            |                          |
| Setpoint                | 65°C                     |
| Duration                | 20Min                    |
| Finish Time             | 120Min                   |

If user uses sanitary hot water directly out from the HWT (hot water tank), for the health purpose, it's requested that he needs to heat up the water inside the tank over 60°C for anti-legionella purpose once a week.

**Note:** Please always refers to local regulation for a correct usage of this function.

#### 6.01 Anti-Legionella Program

Turn ON/ OFF Anti-Legionella function.

#### 6.02 Day and Time

Set at which time in which weekday(s) for the start of anti-legionella operation.

#### 6.03 Setpoint

Set the target sanitary hot water temperature for anti-legionella. Please refers to the local regulation for the correct setting of this temperature.

#### 6.04 Duration

Set for how long the unit should try to keep this set high temperature, to ensure all bacteria in the shower water tank can be killed.

#### 6.05 Finish Time

Set an ending time for this anti-legionella function, even it is not finished successfully. This time should be longer than what it is set in parameter 6.04 .



# 4. Usage

## 7. Vacation Mode

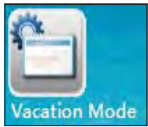

|  |                          |
|--|--------------------------|
| Vacation Mode                                      | <input type="checkbox"/> |
| Sanitary Hot Water temp. Drop during Vacation Mode | 20°C                     |
| Heating Water temp. Drop during Vacation Mode      | 20°C                     |
| Vacation Start Date                                | 1.1.2015                 |
| Vacation Finish Date                               | 1.2.2015                 |

If you need to be away from house for some days, you can use this Vacation Mode function to reduce the set temperatures for both sanitary hot water and house heating, to save more energy.

### 7.01) Vacation Mode

Turn ON/OFF Vacation Mode.

### 7.02) Sanitary Hot Water Temp. Drop During Vacation Mode

Set a temperature drop for sanitary hot water based on standard DHW set value during the set time period for vacation mode.

### 7.03) Heating Water Temp. Drop During Vacation Mode

Set a temperature drop for heating based on standard DHW set value during the set time period for vacation mode.

### 7.04) Vacation Start Date

Set the date that vacation starts.

### 7.05) Vacation Finish Date

Set the date that vacation finishes.

# 4. Usage

## 8. User Management



|                              |  |
|------------------------------|--|
| Permission Level             | End User                                 |
| Heating/Cooling ON/OFF Timer | <input type="checkbox"/>                 |
| Heating/Cooling ON/OFF Timer |  |
| Language                     | English                                  |
| Set Date and Time            | 5.5.2016 18:48                           |
| Distribution System Setting  | W/HC(Sanitary Hot Water/Heating+Cooling) |
| Save Current Settings        |  |
| Load Saved Settings          |  |
| Reset to Factory Settings    |  |

### 8.01) Permission Level

For the safety of the product, some parameters can only be adjusted under installer's permission level. The permission level can be changed in this menu. A password is needed for activating the installer's permission level.

### 8.02) Heating/Cooling ON/OFF Timer

To turn ON/OFF the timer function for heating/cooling operation.

### 8.03) Heating/Cooling ON/OFF Timer

Set the ON and OFF timer for the heating/cooling operation. Different time periods for every weekdays in a week can be set.



## 4. Usage

---

### 8.04) Language

Set system language.

### 8.05) Set Date and Time

Set system clock date and time.

### 8.06) Distribution System Setting

The unit is default set to have 3-way motorized valve inside the unit, which has different flow directions for sanitary hot water/cooling+heating mode.

If user needs to have sanitary hot water and heating on the same distribution system, he can set this parameter to “Hot Water+Heating/Cooling” .

**Note: If it is set to "Sanitary Hot Water+Heating/Cooling", temperature sensor for sanitary hot water (Tw) will be used for the control of heating operation also. Please place it either inside an ideal position in Hot Water Tank.**

### 8.07) Save Current Settings

This parameter is used by installer to save the current settings as “Installer Settings” , so the customer can load the saved settings into the system, when needed.

### 8.08) Load Saved Settings

Loaded the saved “Installer Settings” .

### 8.09) Reset to Factory Settings

Reset the whole system back to factory default settings.

Note: Saved “Installer Settings” will be cleared.

**Note: Most of above menus and parameters are designed for installer only. They should only be adjusted by installer or professional customer under the instruction of installer, otherwise malfunction of the unit may happen.**

# 4. Usage

## 9. Mode Settings

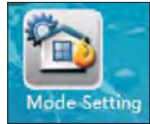

|   |                                     |
|---|-------------------------------------|
| Sanitary Hot Water                            | <input checked="" type="checkbox"/> |
| Heating                                       | <input checked="" type="checkbox"/> |
| Cooling                                       | <input checked="" type="checkbox"/> |
| Basic Operation Modes                         | <input checked="" type="checkbox"/> |
| Max Allowed Duration For Min Compressor Speed | 20Min                               |
| Cooling and Heating Switch                    | Ambient Temp.                       |
| Ambient Temp. To Start Heating                | 18°C                                |
| Ambient Temp. To Start Cooling                | 25°C                                |

### 9.01) Sanitary Hot Water

Set whether the system has sanitary hot water circuit or not. When unit works in Sanitary Water mode, 3-way motorized valve will guide water to HWT automatically.

### 9.02) Heating

Set whether the system has water circuit for house heating purpose or not. When unit works in heating mode, 3-way motorized valve will guide water to heating circuit automatically.

### 9.03) Cooling

Set whether the system has water circuit for house cooling purpose or not. When unit works in cooling mode, 3-way motorized valve will guide water to cooling circuit automatically.

**Note: As whether the system can work in hot water, heating or cooling mode depend quite much on the distribution system, these setting can only be done under installer level, to ensure the safety of the distribution system.**

### 9.04) Basic Operation Mode

This parameter is used to set the basic operation modes, as “Water Temperature Control” or “Room Temperature Control” .

When "Basic Operation Mode" is activated, unit takes room temperature as control object.

When "Basic Operation Mode" is not activated, unit takes water temperature as control object.

Heating or cooling function take water as the control object as default. However when a room temperature sensor is connected to the unit and a more precise control of room temperature where the sensor is placed is preferred, “Room Temperature Control” mode can be selected.

**Note: When “Room Temperature Control” mode is selected, system will not operate under the heating curve function and actual water temperature may swing significantly.**

## 4. Usage

### 9.05) Max Allowed Duration For Min Compressor Speed

When unit output is higher than demand, compressor speed will be reduced. If compressor has continuously worked in minimum compressor speed for over time set via “Max Allowed Duration For Min Compressor Speed” , unit stops.

### 9.06) Cooling and Heating Switch

This function is for having the unit start cooling or heating operation automatically, according to:

◆ If setting = “Ambient Temp” , system will automatically choose cooling or heating operation based on the outdoor ambient temperature, compared with parameter set in 9.07 and 9.08.

◆ If setting = “External Signal Control” , an external room thermostat or central control system in the building can control the cooling or heating requirements by connecting it to the respective signal ports.

The signals are simple 1-0 (on-off) signal. If cooling port receives the signal, the system switches to cooling; If heating port receives the signal, the system switches to heating. When neither port receives the signal, the system stays in standby mode.

◆ If setting = “Ambient Temp.+External Signal Control” , unit will take both the ambient temperature and external signal into consideration for cooling or heating mode selection.

#### Note:

**If parameter is set to OFF, auto switch function is not activated. Then make sure that parameter (Heating Water Circuit) and (Cooling Water Circuit) are not set to ON simultaneously, as the system can not determine actual requirement, due to mode conflict.**

**To avoid mode conflict, if “External Signal Control” is used to take control, please ensure that the external signal will not be activated at the cooling and heating ports at the same time.**

### 9.07) Ambient Temp. To Start Heating

This parameter is used to set the ambient temperature to start the heating operation.

For example, if default value is 18°C, the system will start heating operation automatically when ambient temperature is lower than 18°C.

The setting is only available when parameter “Cooling and Heating Switch “=” Ambient Temp. Or “Ambient Temp.+External Signal Control” .

### 9.08) Ambient Temp. To Start Cooling

This parameter is used to set the ambient temperature to start the cooling operation.

For example, if set value is 28°C, the system will start heating operation automatically when ambient temperature is higher than 28°C.

The setting is only available when parameter “Cooling and Heating Switch “=” Ambient Temp. Or “Ambient Temp.+External Signal Control” .

Note: In order to avoid short cycling between different modes, unit will also take the average temperature in the past time for reference of choosing the working mode.

# 4. Usage

## 10. Backup Heating



|   |                          |
|---|--------------------------|
| Backup Heating Sources For Heating              | <input type="checkbox"/> |
| Priority for Backup Heating Sources (HBH)       | Lower than AH            |
| Backup Heating Source for Sanitary Hot Water    | <input type="checkbox"/> |
| Priority for Backup Heating Sources (HWTBH)     | Higher than AH           |
| Heating Source Start Accumulating Value (HBH)   | 60                       |
| Water Temperature Rise Reading Interval (HWTBH) | 10Min                    |
| Emergency Operation                             | <input type="checkbox"/> |

- ◆ AH---Auxiliary Heater inside the indoor unit
- ◆ HBH---Heating Back-up Heater
- ◆ HWTBH---Hot Water Tank Back-up Heater

### 10.01) Backup Heating Sources For Heating

Set whether the system has HBH (Heating Back-up Heater).

### 10.02) Priority for Backup Heating Sources (HBH)

Set the priority of HBH compared with unit AH (Auxiliary Electric Heater inside the indoor unit).

When unit works in heating, if heat pump unit can't provide enough power, it will turn on AH or HBH (which set to have the higher priority) automatically. If after AH or HBH is working, that the total output power is still not big enough, unit will turn on the lower priority Backup Heating Source also.

### 10.03) Backup Heating Source for Sanitary Hot Water

Set whether the system has HWTBH (Hot Water Tank Back-up Heater).

### 10.04) Priority for Backup Heating Sources (HWTBH)

Set the priority of HWTBH compared with unit AH (Auxiliary Electric Heater inside the indoor unit).

When unit works in hot water, if heat pump unit can't provide enough power, it will turn on AH or HWTBH (which set to have the higher priority) automatically. If after AH or HWTBH is working, that the total output power is still not big enough, unit will turn on the lower priority Backup Heating Source also.

### 10.05) External Heating Source Start Accumulating Value

Accumulated Value between operation time VS set temp. to start other heating source for heating operation.

## 4. Usage

This is for adjusting how fast Backup Heating Sources for heating operation will be turned ON if heat pump unit can't provide enough power. The bigger the value is set, longer time it takes to start the Backup Heating Sources if heat pump capacity is not enough.

### 10.06) Water Temperature Rise Reading Interval

Time interval for checking the temperature increase when unit works in DHW mode. If temperature increases too slow during this set interval time, unit will activate other heating source for DHW operation.

The smaller the value is set, unit is more likely to activate AH or HWTBH for a fast heating of DHW.

#### Backup Heating for DHW

If system has no HWTBH (set via parameter 10.03), or HWTBH has lower priority than AH (set via parameter 10.04) :

◆ If heat pump capacity is not enough to heat up DHW fast enough, unit starts AH. If after AH starts, it still cannot heat up DHW fast enough, HWTBH starts.

◆ When the set and actual water temperature is higher than heat pump maximum allowable water temperature, heat pump stops and unit starts AH. If after AH starts, hot water temperature still increases too slow, HWTBH starts.

If system has HWTBH (set via parameter 10.03), and HWTBH has higher priority than AH (set via parameter 10.04) :

If system has HWTBH (set via parameter 10.03), and HWTBH has higher priority than AH (set via parameter 10.04) :

◆ When the set and actual water temperature is higher than heat pump maximum allowable water temperature, HWTBH works ALONE for DHW while heat pump unit will work in heating or cooling mode according to demand.

◆ When actual water temperature is lower than heat pump maximum allowable water temperature, heat pump works in hot water mode. If heat pump capacity is not enough to heat up DHW fast enough, unit starts HWTBH. If after HWTBH starts, hot water temperature still increases too slow, AH starts.

Under shifting priority operation, according to parameter 3.08, AH or AH+HWTBH work together with heat pump to heat sanitary hot water to the set value as soon as possible, so heat pump unit can concentrate on heating mode afterwards.

### 10.07) Emergency Operation

When heat pump failed to work, whether the unit should turn ON the back-up heating system automatically.

Note: If this function is activated, customer should check the working status of heat pump unit occasionally, to ensure heat pump unit is functioning well.

# 4. Usage

## 11. Water Pump Settings



|                                      |                                |
|--------------------------------------|--------------------------------|
| Circulation Pump P0 Type             | DC Variable Speed Pump ( PWM ) |
| Speed Setting of Circulation Pump P0 | High Speed                     |
| Working Mode of Circulation Pump P0  | Interval working mode          |
| Pump Off Interval for P0             | 10Min                          |
| Pump On Time for P0                  | 1Min                           |

|                           |                          |
|---------------------------|--------------------------|
| Buffer Tank               | <input type="checkbox"/> |
| P1 for Heating Operation  | <input type="checkbox"/> |
| P1 for Cooling Operation  | <input type="checkbox"/> |
| P1 with High Temp. Demand | <input type="checkbox"/> |
| P2 for Heating Operation  | <input type="checkbox"/> |

|                           |                          |
|---------------------------|--------------------------|
| P2 for Cooling Operation  | <input type="checkbox"/> |
| P2 with High Temp. Demand | <input type="checkbox"/> |

### 11.1) Circulation Pump P0 Type

This is to set the type of circulation pump inside the unit, P0.

### 11.2) Speed Setting of Circulation Pump P0

This is to set the working speed of circulation pump inside the unit, P0.

### 11.3) Working Mode of Circulation Pump P0

This is to set the working mode of circulation pump for cooling/heating operation inside the unit, P0.

P0 can work as the following settings:

1. Interval working mode. In this setting, P0 stops after compressor stops, but runs for a while after stops for an interval period.
2. ON constantly. P0 will work constantly even if compressor stops after reaching the set temperature.
3. OFF with compressor. It means P0 stops after compressor stops.

### 11.4) Pump OFF Interval

### 11.5) Pump On Time

If unit circulation pump P0 working mode is set to “Interval working mode”, that means circulation pump stops after compressor stops, but after it stops, it will runs for [11.5] minutes after stops for every [11.4] minutes interval time.

### 11.6 Buffer Tank

### 11.7 P1 for Heating Operation

### 11.8 P1 for Cooling Operation

### 11.9 P1 with High Temp. Demand

### 11.10 P2 for Heating Operation

### 11.11 P2 for Cooling Operation

### 11.12 P2 with High Temp. Demand

These parameters are used for setting the working of external circulation pump P1 and P2, for heating/cooling circuit, (HC/CC 1) and heating/cooling circuit, (HC/CC 2).

For more details, please refers to chapter 2.1.3~2.1.5.



# 4. Usage

## 12. Floor Curing



|   |                          |
|---|--------------------------|
| Floor Curing                                  | <input type="checkbox"/> |
| Floor Curing Temperature Setting Stage 1      | 30°C                     |
| Floor Curing Operation Duration Stage 1       | 8Hour                    |
| Floor Curing Temperature Setting Stage 2      | 38°C                     |
| Floor Curing Operation Duration Stage 2       | 12Hour                   |
| Floor Curing Running Hours                    | 0Hour                    |
| Highest Water Temp. in Floor Curing Operation | 0°C                      |

After initial Installation or Long Time Non-operation, a floor heating system may be very wet in the concrete. Most of the heating capacity from heat pump unit is consumed to dry up the water in the concrete for its evaporation. This floor curing function is used to dry the floor to ensure the safety of heat pump system.

### 12.1) Floor Curing

Turn ON/OFF this function. For a newly-built floor heating system, floor must be cured before setting the heat pump into standard working mode.

### 12.2) Floor Curing Temperature Setting Stage 1

### 12.3) Floor Curing Operation Duration Stage 1

Set temperature and lasting time for first-stage of Floor Curing operation.

### 12.4) Floor Curing Temperature Setting Stage 2

### 12.5) Floor Curing Operation Duration Stage 2

Set temperature and lasting time for second-stage of Floor Curing operation.

### 12.6) Floor Curing Running Hours

### 12.7) Highest Water Temp. in Floor Curing Operation

Three two values are operation data during floor curing operation. Unit will take down the operation time and highest water temperature the system has reached during Floor Curing operation.

**Note: After Floor Curing operation is finished, if water temperature inside the distribution system is still far below the set value of [12.4], it means there has still some water inside the concrete of floor heating system, thus Floor Curing function should be turned ON again, until temperature can increase over [12.4].**

## 4. Usage

### 13. Electrical Utility Lock



|   |                          |
|---|--------------------------|
| Electrical Utility Lock                             | <input type="checkbox"/> |
| Operation Signal for Electrical Utility Lock        | Normal Open              |
| HBH During Electrical Utility Lock                  | <input type="checkbox"/> |
| Working Mode of Pump During Electrical Utility Lock | <input type="checkbox"/> |

Some electricity companies offer a special rate to the houses who lowered their power consumption during peak time. When peak time comes, electricity company will send an ON or OFF signal to every house, indicating that they hope the house owners to turn OFF some electric equipments.

This system can be connected to the unit if the unit is supposed to stop working during this period, and use the following parameter settings to activate this function.

#### 13.1) Electrical Utility Lock

Set ON/OFF Electrical Utility Lock function.

#### 13.2) Operation Signal for Electrical Utility Lock

Set the type of signal from electricity company. “Normally Open” means when unit can work as normal when it gets ON signal; the unit should stop working when it receives a OFF signal; “Normally Close” means the opposite.

#### 13.3) HBH During Electrical Utility Lock

Set whether turn on HBH (Heating Back-up Heater), when unit is blocked by Electrical Utility Lock. e. g. gas boiler.

#### 13.4) Working Mode of Pump During Electrical Utility Lock

Set the working of circulation pump when unit is blocked by Electrical Utility Lock.

If it's activated, the circulation pump will keep on working when compressor stops.

If it's not activated, the circulation pump will stop working when compressor stops.

# 4. Usage

## 14. Other Options

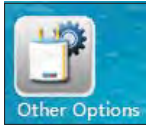

|  |      |
|--|------|
| Ambient Temp. to Activate First Class Anti-freezing  | 6°C  |
| Ambient Temp. to Activate Second Class Anti-freezing | 4°C  |
| Ambient Temp. to Stop Second Class Anti-freezing     | 6°C  |
| Water Temp. to Activate Second Class Anti-freezing   | 5°C  |
| Water Temp. to Stop Second Class Anti-freezing       | 12°C |

|   |                          |
|---|--------------------------|
| Motorized Diverting Valve switching time    | 1Min                     |
| Power On Time for Motorized Diverting Valve | 1Min                     |
| Refrigerant Recycle Function                | 0S                       |
| Control Panel Backlight Light               | Always ON                |
| Exit System                                 |                          |
| Mode Switch during Defrosting               | <input type="checkbox"/> |
| Fan Speed Limit                             | 100%                     |

### 14.1) Motorized Diverting Valve Switching Time

Set how many minutes as switching time of the motorized diverting valve spending on switching the water flow fully between DHW and Heating/Cooling circuit.

Note: This parameter must comply with the motorized diverting valve. Otherwise unit may not be able to work due to not enough water flow rate.

### 14.2) Power On Time for Motorized Diverting Valve

Set how long the motorized diverting valve should be powered, for switching the water flow fully between DHW and Heating/Cooling circuit.

### 14.3) Refrigerant Recycle

This function can be used by installers to recycle the refrigerant in the complete system into condensing unit for service purpose. When it is activated, unit will be forced to work in cooling operation for some time, to push all refrigerant back to condensing unit.

### 14.4) Control Panel Backlight

Set the backlight touch screen operation panel to be "Always on" or how long before it becomes off for energy saving.

### 14.5) Exit System

Exit from unit program and returns to WINCE operation system. This is used for software updating.

## 4. Usage

### 14.6) Ambient Temp. to activate first class anti-freezing

### 14.7) Ambient Temp. to activate second class anti-freezing

### 14.8) Ambient Temp. to stop second class anti-freezing

### 14.9) Water Temp. to activate second class anti-freezing

### 14.10) Water Temp. to stop second class anti-freezing

These parameters are used for setting the anti-freezing protection of the unit in winter time, when unit is powered but turned OFF.

When ambient temperature is lower than first class anti-freezing starting ambient temperature, unit will circulate the water in the system at interval for anti-freezing.

When ambient temperature drops below second class anti-freezing starting ambient Temperature, heat pump unit will start either compressor or backup heating sources to maintain the water temperature within the range “Water Temp. to activate second class anti-freezing” and “Water Temp. To stop second class anti-freezing” .

**Note: This function is provided to the customer FREE OF CHARGE for helping their house heating and DHW water system free from freezing up. Customer should always have his own protection system for preventing the water system from freezing up. We have no responsibility or obligation if any damage has caused by water freezing.**

### 14.11) Mode Switch during Defrosting

If water temperature is too low, the condenser may have the risk of freezing up and cause damage the complete refrigerant system. Thus, if water temperature in current working mode is too low for defrosting, unit will check the water temperature in other circuit. If the water temperature in other circuit is good enough for defrosting, it will switch the water flow to this circuit for defrosting operation automatically.

If there is no other circuit, or the water temp in other circuit is also not high enough for defrosting, unit will stop defrosting and automatically lift up the set water temperature, preparing for the next defrosting cycle.

If defrosting failed for over three times continuously, unit stops and can only be recovered by re-powering the machine. Please check the water system at this moment to ensure everything works properly before re-powering the unit.

Note: This function can only work with outdoor software higher than AC13I20.WP.V004\_T01 or AC13I17.WP.V009\_T01, otherwise this function will interrupt the working of the machine during defrosting all the time.

### 14.12) Fan Speed Limit

This function is for reducing the fan speed in order to reduce the noise, however it would reduce the performance of the heat pump at the same time. The fan speed limitation can be set at down to two levels 95% and 90%. This function is not recommended unless the noise is strongly complained by customer/neighbor.

## 4. Usage

---

### 15. Unit Real-time Data



This menu is designed for viewing the running data of the system. Following parameters that are related to the working of the system can be viewed in this menu:

- 01): Control System Version No
- 02): Database Version
- 03): Heat Exchanger Water Outlet Temperature-Indoor - Tuo
- 04): Heat Exchanger Water Return Temperature-Indoor - Tui
- 05): Indoor Coil Temp. - Tup
- 06): Sanitary Hot Water Temp.- TW
- 07): Cooling/Heating Water Temp. -TC
- 08): Water Flow Rate
- 09): Compressor Working Speed
- 10): EEV Openings
- 11): Actual Ambient Temp.
- 12): Average Ambient Temp. in 1 Hour
- 13): Average Ambient Temp. in 24 Hour
- 14) High Pressure - Pd
- 15): Low Pressure - Ps
- 16): Discharge Temp. - Td
- 17): Suction Temp. - Ts
- 18): Outdoor Coil Temp. - Tp
- 19): Source Side Water Inlet temperature (For Water to Water unit only)
- 20): Source Side Water Outlet temperature (For Water to Water unit only)
- 21): Fan Speed
- 22): Fan Speed 2
- 23): Outdoor Unit Working Current
- 24): Voltage
- 25): Eeprom Version No.

# 4. Usage

## Info

Press "Info" to view water system and water system working status. -----

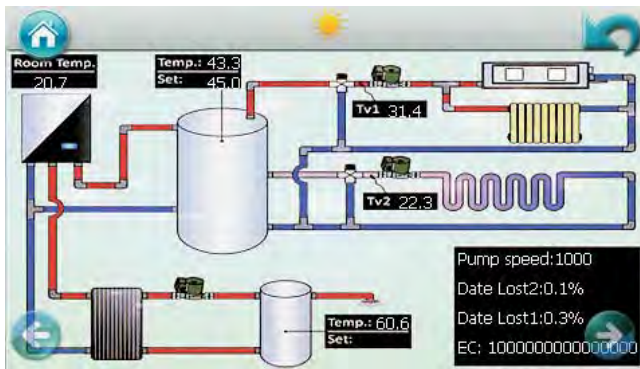
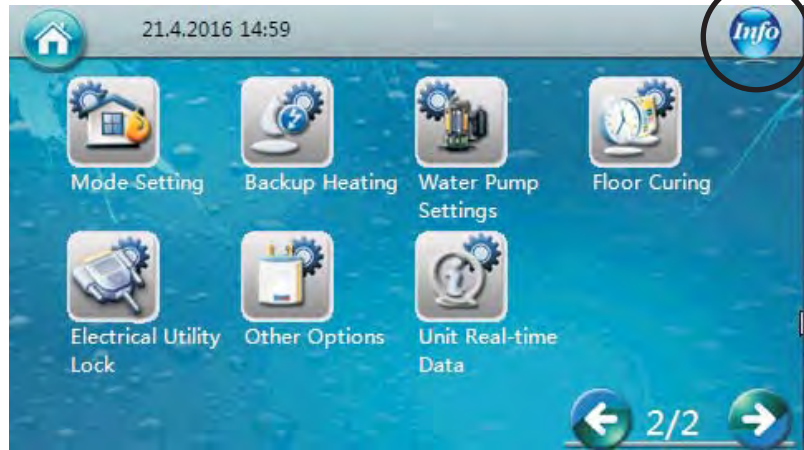

| Active Errors:                             | Cleared Errors:  |
|--|--|
| F28<br>1/15/2015 12:26 PM -DC pump failure | F14<br>1/15/2015 12:19 PM -Sanitary hot water temperature sensor failure |
| F28 12:26 PM                               | F30 1/17/2015  |
|  | E01 1/15/2015  |
|  | F29 1/17/2015  |
|  | S03 1/15/2015  |
|  | F28 1/15/2015  |
|  | F14 1/15/2015  |
|  | F15 1/15/2015  |
|  | F30 1/17/2015  |
|  | E01 1/15/2015  |

Display of Failure Code

Display of Failure

Record of Previous Failure

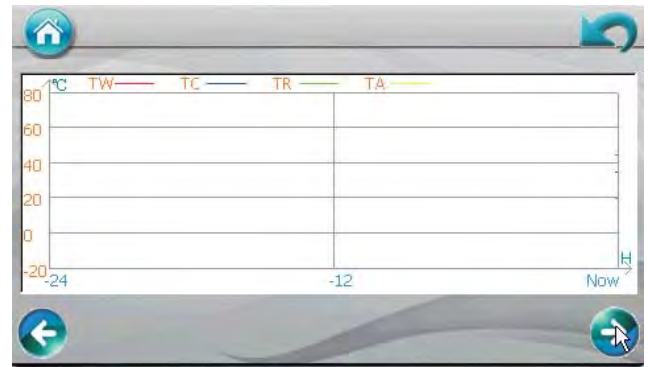
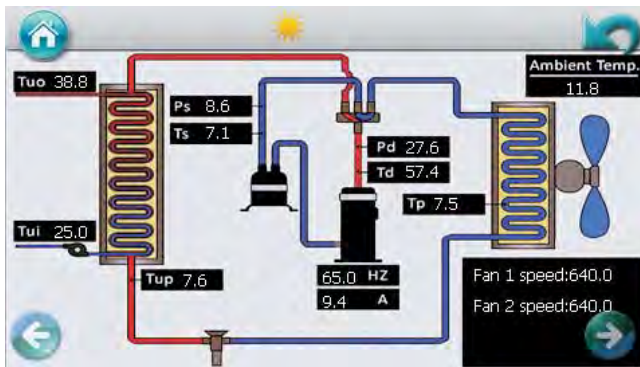

TW----Water temperature for Sanitary hot water tank  
 TC----Water temperature for buffer tank  
 TR----Room temperature  
 TA-----Ambient temperature

## 4. Usage

### Home

Home: Press this button at any page, operation panel goes back to home page.---

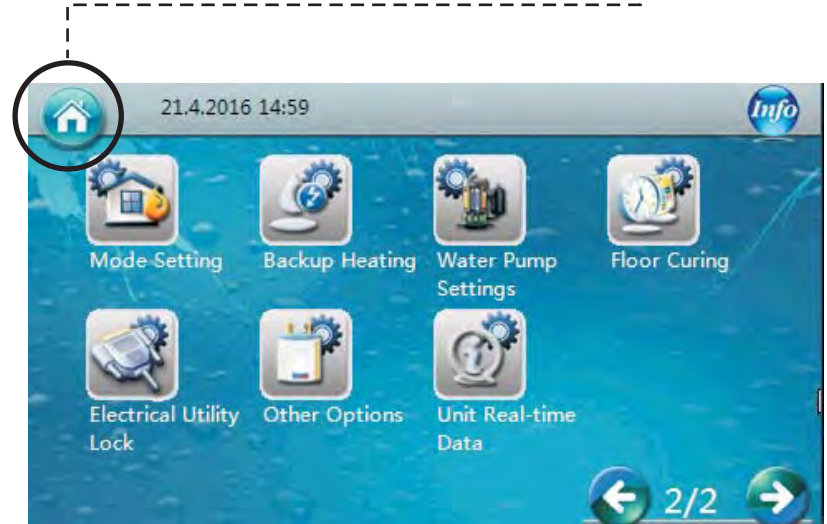

## 4. Usage

### 4.3 Electric heater

The inbuilt electric heater can be used as a back-up heater or auxiliary heater to our heat pump unit, when ambient temperature is too low, or heat pump fails to work properly, which causes insufficient heat.

This heater will start to work when any of following two conditions is met:

1. Water temperature is lower than what is set via digital thermostat for electric heater.
2. Heat pump unit thinks its capacity is not enough, so it turns ON the heater.

#### Notice!

- ◆ There is a separate power cable for electric heater on top of indoor unit. It supplies the power to electric heater directly.
- ◆ Make sure the unit is full of water before turning it on.
- ◆ Do not touch it to get burned when it is turned on. High temperature here.
- ◆ Make sure the power supply to the heater corresponds to the specifications.
- ◆ The installation, dismantlement and maintenance of the heater must be performed by qualified personnel. It is forbidden to do any changes to the structure of the heater.
- ◆ Digital thermostat is default set to 30°C.
- ◆ Maximum set temperature of digital thermostat is 120°C. But it is strongly suggest not to set the temperature over 75°C, otherwise it may make the unit build up too high pressure inside and cause damage or danger.

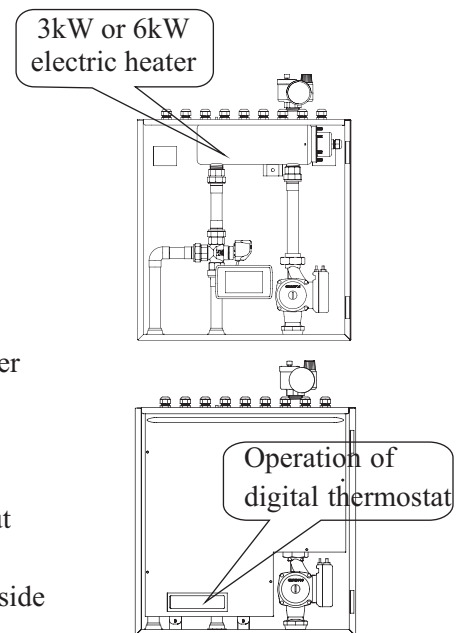

This heater (AH) is controlled by heat pump unit automatically according to the parameter setting in menu "Backup Heating".

In case the heat pump control system breaks down, customer can manual set a set temperature for water circulates through the unit via the digital thermostat for Electric Heater (AH).





Important Notice: Before turn ON the thermostat, system must be full filled with water and correctly air purged, otherwise electric may get over heat and cause fire.

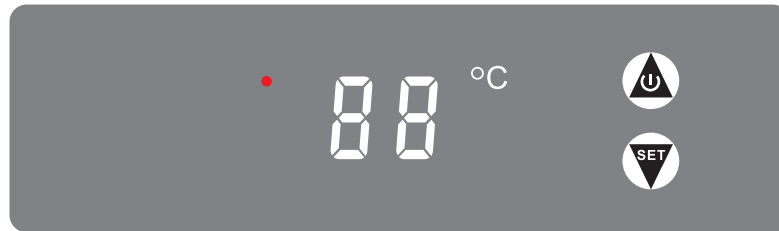

# 4. Usage

## Operation of digital thermostat



- 1) Press  for 3 seconds to turn ON OFF of the electric heater. When heater is turned OFF, it shows "- - -".
- 2) When heater is turned ON, press  for 3 seconds to show the set temperature. After release, this set temperature blinks on the display.
- 3) When set temperature is blinking, press  or  to increase or decrease the set temperature of electric heater.
- 4) Controller will save this setting and show actual water temperature in the display if no operation in 6 seconds.

## 4.4 Failure codes

### 【Outdoor】

| Type       | Code | Description  | Blinking times | Unit working statue | Solution  |
|------------|------|--|----------------|---------------------|---|
| Protection | P01  | Main line current protection   | 1              | Compressor stops    | Input current too high or too low, or system works in over-load condition. Unit recovers automatically after 5 minutes when it happened the first time. If same failure happened 3 times in a certain period of time, unit stops until repowered. Check unit input current. Check whether fan motor and water pump is working OK; whether condenser is blocked; whether water temperature too high, and whether water inlet&outlet temperature has too big difference (should no bigger than 8°C) |
|            | P02  | Compressor phase current protection  | 2              | Compressor stops    | Compressor input current too high or too low, or system works in over-load condition. Check compressor input current. Check whether fan motor and water pump is working OK; whether condenser is blocked; whether water temperature too high, and whether water inlet&outlet temperature has too big difference (should no bigger than 8°C)   |
|            | P03  | IPM module protection  | 3              | Compressor stops    | Compressor drive failure. Check whether cable is broken or loosen. Check whether compressor driver PCB or compressor is broken.   |
|            | P04  | Compressor oil return protection   | 4              | Compressor speed up | If unit has been continuously working in low speed for certain period of time, unit starts this protection to suck compressor oil back into compressor. This is a normal protection and doesn't need any treatment.   |
|            | P05  | Compressor shut down due to high/low pressure switch open caused by abnormal high/low pressure | 5              | Compressor stops    | If system pressure is too high or too low, it activates this protection. Unit recovers automatically after 5 minutes when it happened the first time. If same failure happened 3 times in a certain period of time, unit stops until repowered. Check whether fan motor and water pump is working OK; whether condenser is blocked; whether water temperature too high, and whether water inlet&outlet temperature has too big difference (should no bigger than 8°C)                             |

## 4. Usage

| Type       | Code | Description  | Blinking times | Unit working statue                            | Solution  |
|------------|------|--|----------------|--|---|
| Protection | P06  | Compressor speed down due to abnormal high pressure detected by condensing pressure sensor | 6              | Compressor stops                               | If system pressure is too high , it activates this protection. Unit recovers automatically after 5 minutes when it happened the first time. If same failure happened 3 times in a certain period of time, unit stops until repowered. Check whether fan motor and water pump is working OK; whether condenser is blocked; whether water temperature too high, and whether water inlet&outlet temperature has too big difference (should no bigger than 8℃)  |
|            | P07  | Compressor preheating  | 7              | Standard function, doesn't need any treatment. | This is a normal protection and doesn't need any treatment. When compressor did not work for long time and ambient temperature is low, compressor crankcase heater work for certain period of time before compressor start to warm up the compressor.   |
|            | P08  | Compressor discharge temp. too high protection   | 8              | Compressor stops                               | Check whether water temperature set value is too high, especially when ambient temperature is low; whether water flow rate too small; whether system is lacking of enough refrigerant.  |
|            | P09  | Outdoor evaporator coil temp. sensor protection  | 9              | Compressor stops                               | Check whether air circulates fluently in outdoor unit.  |
|            | P10  | AC over high/low voltage protection  | 10             | Compressor stops                               | Unit input voltage too high or too low. Check the voltage of unit power supply.   |
|            | P11  | Compressor shut down due to too high/low ambient temperature                               | 11             | Compressor stops                               | Ambient temperature is too high or too low for unit to work.  |
|            | P12  | Compressor speed limit due to too high/low ambient temperature                             | 0              | Compressor speed down                          | This is a normal protection and doesn't need any treatment.   |
|            | P14  | Compressor speed down due to abnormal low pressure detected by condensing pressure sensor  | 14             | Compressor stops                               | If system pressure is too low , it activates this protection. Unit recovers automatically after 5 minutes when it happened the first time. If same failure happened 3 times in a certain period of time, unit stops until repowered. Check whether system has not enough refrigerant or leakage inside(more likely it is not enough refrigerant that caused this abnormal evaporating pressure); whether fan motor and water pump is working OK; whether condenser is blocked; whether EEV whether EEV works normally; whether water temperature too low, and whether water inlet&outlet temperature has too big difference in cooling(should no bigger than 8℃). |
| Failure    | F01  | Outdoor ambient temp. sensor failure   | 17             | Compressor stops                               | Check whether ambient temperature sensor is open, short-circuit or value drifts too much. Replace it if necessary.  |
|            | F02  | Outdoor evaporator coil temp. sensor failure   | 18             | Compressor stops                               | Check whether outdoor coil temperature sensor is open, short-circuit or value drifts too much. Replace it if necessary.   |
|            | F03  | Compressor discharge temp. sensor failure  | 19             | Compressor stops                               | Check whether compressor discharge temperature sensor is open, short-circuit or value drifts too much. Replace it if necessary.   |
|            | F04  | Outdoor Suction temp. sensor failure   | 20             | Compressor stops                               | Check whether outdoor suction temperature sensor is open, short-circuit or value drifts too much. Replace it if necessary.  |
|            | F05  | Evaporating pressure sensor failure  | 21             | Compressor stops                               | Check whether evaporating temperature sensor is open, short-circuit or broken. Replace it if necessary.   |
|            | F06  | Condensing pressure sensor failure   | 22             | Compressor stops                               | Check whether condensing temperature sensor is open, short-circuit or broken. Replace it if necessary.  |
|            | F07  | High/low pressure switch failure   | 23             | Compressor stops                               | If pressure switch is in open position when unit is in standby statue, or 2 minutes after compressor stops, unit gives this failure. Check whether high or low pressure switch is broken or not well connected.   |
|            | F09  | DC fan failure (one)   | 25             | Compressor speed down                          | Speed of DC fan or one of the DC fan (for dual fan system) can't reach the required value or no feedback signal. Please check whether the PCB or fan motor is broken.   |

## 4. Usage

| Type                  | Code | Description   | Blinking times | Unit working statue | Solution  |
|-----------------------|------|---|----------------|---------------------|---|
| <b>Failure</b>        | F10  | DC fan failure (two)  | 26             | Compressor stops    | Speed of both DC fans (for dual fan system) can't reach the required value or no feedback signal. Please check whether the PCB or fan motor is broken.  |
|                       | F11  | System evaporating pressure too low   | 27             | Compressor stops    | If system too low pressure protection detected by evaporating pressure sensor happened 3 times in a certain period of time, it gives this failure code and unit can't be restarted until repowered. Check whether system has not enough refrigerant or leakage inside (more likely it is not enough refrigerant that caused this abnormal evaporating pressure); whether fan motor and water pump is working OK; whether condenser is blocked; whether EEV whether EEV works normally; whether water temperature too low, and whether water inlet&outlet temperature has too big difference in cooling (should no bigger than 8°C). |
|                       | F12  | System condensing pressure too high   | 28             | Compressor stops    | If system too high pressure protection detected by condensing pressure sensor happened 3 times in a certain period of time, it gives this failure code and unit can't be restarted until repowered. Check whether water flow rate is not enough (more likely it is not enough water flow rate that caused system build up too high pressure); whether fan motor and water pump is working OK; whether condenser is blocked; whether EEV works normally; whether water temperature too high, and whether water inlet&outlet temperature has too big difference (should no bigger than 8°C)   |
| <b>System failure</b> | E01  | Communication between operation panel and indoor PCB or outdoor PCB failure | 33             | Compressor stops    | Communication failure between operation panel and the indoor or outdoor PCB. Check the cable connection in between. Check whether the last three switches on outdoor power PCB are set to 001; Whether four switches on indoor PCB are set to 1000. Unit recovers when communication recovers.  |
|                       | E02  | Communication between outdoor main control PCB and module PCB               | 34             | Compressor stops    | Check the communication cable between outdoor power PCB and deiver PCB. Check whether outdoor power PCB and deiver PCB is broken.   |
|                       | E03  | Compressor phase current failure (open/short circuit)                       | 35             | Compressor stops    | Check whether the power cable to compressor is broken or short-circuit.   |
|                       | E04  | Compressor phase current overload (over current)                            | 36             | Compressor stops    | Check whether the power cable to compressor is broken or short-circuit.   |
|                       | E05  | Compressor driver failure   | 37             | Compressor stops    | Check whether compressor drive PCB is broken, or cable to compressor is wrong connected.  |
|                       | E06  | Module VDC over high/low voltage failure                                    | 38             | Compressor stops    | Input voltage too high or too low.  |
|                       | E07  | AC current failure  | 39             | Compressor stops    | Check the current to outdoor unit, and compare it with the unit current shown on the operation panel. If the difference is not big, check whether the system has enough refrigerant (more likely it is not enough refrigerant that caused this abnormal low current). If the difference is big, outdoor power PCB is broken. Please replace it with a new one.  |
|                       | E08  | EEPROM failure  | 40             | Compressor stops    | Cut the unit power and short-circuit JP404 port on outdoor power PCB, repower the unit, cut power again and cancel the short-circuit on JP404 port. If still not OK, replace the outdoor power PCB.   |

## 4. Usage

### 【Indoor】

| Type       | Code | Description   | Blinking times | Unit working statue                                      | Solution   |
|------------|------|---|----------------|--|--|
| Failure    | F13  | Room temp. sensor failure   | 7              | Unit stops   | Check whether room temperature sensor is open, short-circuit or value drifts too much. Replace it if necessary.  |
|            | F14  | Sanitary hot water temp. sensor failure                                     | 3              | Unit stops   | Check whether sanitary hot water temperature sensor is open, short-circuit or value drifts too much. Replace it if necessary.  |
|            | F15  | Cooling/heating water temp. sensor failure                                  | 6              | Unit stops   | Check whether cooling/heating water temperature sensor is open, short-circuit or value drifts too much. Replace it if necessary.   |
|            | F16  | Unit water outlet temp. sensor failure                                      | 4              | Unit stops   | Check whether unit water outlet temperature sensor is open, short-circuit or value drifts too much. Replace it if necessary.   |
|            | F17  | Unit water inlet temp. sensor failure                                       | 5              | Unit stops   | Check whether unit water inlet temperature sensor is open, short-circuit or value drifts too much. Replace it if necessary.  |
|            | F18  | Indoor coil temp. sensor failure  | 8              | Unit stops   | Check whether indoor temperature sensor is open, short-circuit or value drifts too much. Replace it if necessary.  |
|            | F21  | Mixture valve 1 temperature sensor failure                                  | 11             | Unit keep on working, mixture valve 1 output fixed to 0. | Check whether TV1 temperature sensor is open, short-circuit or value drifts too much. Replace it if necessary.   |
|            | F22  | Mixture valve 2 temperature sensor failure                                  | 12             | Unit keep on working, mixture valve 2 output fixed to 0. | Check whether TV2 temperature sensor is open, short-circuit or value drifts too much. Replace it if necessary.   |
|            | F25  | Communication between operation panel and indoor PCB or outdoor PCB failure | 1              | Unit stops   | Communication failure between operation panel and the indoor or outdoor PCB. Check the cable connection in between. Check whether the last three switches on outdoor power PCB are set to 001; Whether four switches on indoor PCB are set to 1000. Unit recovers when communication recovers.   |
|            | F27  | Indoor EEPROM failure   | 13             | Unit keep on working                                     | Cut the unit power, connect CN213-5 and CN213-6 together, repower the unit and then cut the power and cancel the connect. If still not OK, replace the indoor PCB.   |
|            | F28  | Water pump PWM signal feedback failure                                      | 14             | Unit keep on working                                     | Check water pump cable connection; check power supply to water pump; check whether water pump is broken.   |
|            | F29  | Mixture valve 1 failure   | 17             | Unit keep on working, mixture valve 1 output fixed to 0. | Check MV1 cable connection; check whether PCB output voltage signal; check whether MV1 is broken.  |
|            | F30  | Mixture valve 2 failure   | 18             | Unit keep on working, mixture valve 2 output fixed to 0. | Check MV2 cable connection; check whether PCB output voltage signal; check whether MV2 is broken.  |
| Protection | S01  | Indoor anti-freezing protection in cooling                                  |                | Compressor speed down or stop                            | Compressor speed down if coil temp. lower than 2°C; Compressor stops if coil Temp. lower than -1°C; Compressor restarts if coil Temp. higher than 6°C.<br>1. Check whether set temperature for cooling is too low; whether system has too small water flow rate; check water system especially the filter.<br>2. Check whether system has not enough refrigerant inside by measuring the evaporating pressure.<br>3. Check whether ambient temperature is lower than 15°C. |
|            | S02  | Too small water flow rate   |                | Compressor stops   | System water flow rate is less than minimum allowable flow rate. Check the water system, especially the filter; check the working statue of water pump.  |
|            | S03  | Water flow switch failure   |                | Warning but unit keeps on working                        | Water flow switch failed to work. Check whether flow switch is broken or not well connected.   |
|            | S04  | Communication failure   |                | Unit stops   | Communication data lost too much. Check whether communication cable is longer than 30M; whether there has a source of the disturbance nearby the unit. Unit recovers when communication recovers.  |

# 4. Usage

| Type              | Code | Description   | Blinking times | Unit working statue                   | Solution   |
|-------------------|------|---|----------------|---------------------------------------|--|
| <b>Protection</b> | S05  | Serial port connect error                                   |                | Unit stops                            | Communication failure between operation panel and the indoor or outdoor PCB. Check the cable connection in between. Check whether the last three switches on outdoor power PCB are set to 001; Whether four switches on indoor PCB are set to 1000. Unit recovers when communication recovers.                                       |
|                   | S06  | Water outlet Temp. too low protection in cooling            |                | Compressor stops                      | Compressor stops if water outlet is lower than 5°C in cooling mode. Check whether temperature sensor Tc is OK and well connected; whether set water temperature too low; whether system flow rate too small.   |
|                   | S07  | Water outlet Temp. too high protection in heating/hot water |                | Compressor stops                      | Compressor stops if water outlet is higher than 57°C in heating or hot water mode. Check whether temperature sensor Tc and Tw is OK and well connected; whether set water temperature too high; whether system flow rate too small.  |
|                   | S08  | Defrosting Failure  |                | Compressor stops                      | If unit continuously failed to finish the defrosting operation for three times, it stops and give failure code S08. This can only be recovered by re-powering the machine. Please check whether the actual water temperature is too low for the unit to defrost, so the plate heat exchanger has the risk of freezing up.            |
|                   | S09  | Water Outlet temp. too low protection in heating/hot water  |                | Compressor stops and AH(or HBH) works | If unit stops and AH(or HBH) starts if water outlet temperature is lower than 15°C in heating and hot water mode. Compressor restarts when the temperature is higher than 17°C. This is a protection for protecting the safety of the compressor, as too low water temperature in heating or hot water mode may kill the compressor. |
|                   | S10  | Too small water flow rate failure                           |                | Compressor stops                      | If unit stops due to “too small water flow rate” protection(S02) over three times in certain period of time, units stops and gives S10 failure code. It can only be recovered by re-powering the unit. Check the water system, especially the filter; check the working statue of water pump.  |
|                   | S11  | Indoor anti-freezing protection failure in cooling          |                | Compressor stops                      | If unit stops due to “Indoor anti-freezing protection in cooling(S01)” over three times in certain period of time, units stops and gives S11 failure code. It can only be recovered by re-powering the unit.   |

### 【Indoor PCB】



1. LED indicator light on Indoor PCB

2. Dip switch on indoor PCB  
Factory Default Setting:

ON

OFF

# 5. Maintenance

---

## 5.1 Precaution of maintenance for units with flammable refrigerant

### 1) Requirement about service area and person

Service persons and all other people at site should be well aware about character of maintenance to be carried out. Make sure the service area is not enclosed and keep good ventilation (opening doors and windows). Service area should be properly isolated. And ensure the safety of working conditions in service area by controlling the combustible materials.

### 2) Monitor status of refrigerant

Before or during the service operation, monitoring device is required to keep checking status of refrigerant so that service persons can keep aware about existing combustible gas.

### 3) Storage of fire extinguishers

When hot-working treatment is needed for heat pump system or related components, ensure fire extinguisher is placed nearby. The proper fire extinguisher should be type of dry powder or carbon dioxide.

### 4) Prohibition of fire

Conduct safety inspections at service area to ensure that there is no flames and potential ignition sources (including smoke) and keep strict control in isolating combustible materials.

### 5) Inspection of equipment

If electrical components are to be replaced, they should be installed in accordance with intended use and correct operating regulations.

### 6) Inspection of electrical elements

The service on electrical components should include general security check and inspection of electrical elements. If a defect that could threaten personal safety is found, power off the appliance until the defect is properly solved. If the defect can not be completely eliminated while it is a must to continue the operation, appropriate temporary solutions should be well adopted. Please report the situation to owner of equipment and warn all relevant personnels.

### 7) Inspection of cables

Check the status of cables and verify if any defects happen because of abrasion, corrosion, overpressure, vibration, cut by sharp edges or other reasons. This inspection should also consider the effects because of cable aging and continuous vibration of compressor and the fans.

### 8) Inspection of flammable refrigerants

Inspection of refrigerant leakage should be carried out in service area without fire or any other potential ignition source. And this inspection should not be done by detectors working with ignition, such as halogen probe.

If a leak is suspected, all flames should be removed from service area or extinguished.

If soldering is required at leakage point, it is a must to recover all refrigerant or isolate it at somewhere not close to leakage point (by service valve). Before or in process of soldering, oxygen-free nitrogen (OFN) should be used in order to purify the system.

# 5. Maintenance

## 9) Procedures of service on refrigeration system

The refrigeration circuit should be operated according to the proper procedures. And the flammability of refrigerant should also be considered. Please follow the procedures below.

- Remove refrigerant;
- Purify the pipeline with inert gas;
- Vacuum the refrigerant system;
- Purify the pipeline with inert gas again;
- Cut pipeline or weld it as required.

## 10) Refrigerant charging

As a supplement to regular procedures of refrigerant charging, the following requirements are required.

- Ensure that there is no mutual contamination between different refrigerants during refrigerant charging. The pipeline to fill system with refrigerant should be as short as possible in order to reduce the residual amount of refrigerant in it;
- The refrigerant tank should be kept vertically upwards;
- Ensure that the refrigeration system has been well grounded before charging;
- Label the system after charging is finished(or not yet completed);
- Overfilling is prohibited;

Before refilling the system, a pressure test should be performed with OFN. After charging, a leakage test is required before test run of heat pump. And please have a leakage test again before leaving the service area.

## 11) Precautions of refrigerant charging

Please make sure charging of refrigerant is done with correct amount based on information on unit label.

## 12) Emergency treatment

Emergency plan should be well prepared at service site and daily preventive measures should be carried out. For example, fire is forbidden at site and it is prohibited to wear clothing or shoes which can generate static or sparks.

- Suggested disposal in case of serious leakage of flammable refrigerant:
  - a) Turn on the ventilation equipments and cut off power supply of other devices. Persons should evacuate from site immediately.
  - b) Notify and evacuate the neighbouring people and residents in order and stay away from the site for at least 20 meters. Call the police and set up a warning region forbidding people and vehicles from approaching.
  - c) On-site treatment should be carried out by professional firefighters with anti-static clothing. Cut off the leakage source.
  - d) Purge and eliminate flammable refrigerant and residual gas at leakage point and surrounding area with nitrogen, especially for low-lying areas. Detect and verify the elimination work with professional detector until concentration of flammable refrigerant become zero. Only after that, alarm can be cleared.

## 5. Maintenance

---

### 13) Clearance of refrigerant when maintain, scrap and recycle the equipment

Refrigerant should be cleared when maintain, scrap and recycle the equipment. Discharge the refrigerant in open and ventilated area. After discharging, vacuum the system with a vacuum pump to ensure clearance of residual refrigerant.

When maintain a unit with potential leakage, lock the service valves of outdoor unit and then disconnect refrigerant pipes. Release the refrigerant in indoor unit to the atmosphere. Please be noted that it is prohibited to recover refrigerant when unit is working in order to prevent the air from going into compressor. [For split type of equipment]

### 14) Requirement about storage of R32 refrigerant

● The refrigerant storage tank should be placed separately in the environment with ambient temperature between  $-10\sim 50^{\circ}\text{C}$  and with good ventilation. Warning labels should be placed in this area or on the tanks.

● For service tools in contact with the refrigerant, they should be stored and used separately. And the service tools designed for different refrigerants can not be mixed in usage or storage.

### 15) Operation specification about equipment dismantling

● Before dismantling, check and ensure safety at service area and keep good ventilation (open doors and windows). Ignition sources are prohibited at the place where equipment is dismantled and the combustible materials should be isolated.

● Please clear the refrigerant in equipment before dismantling. [For split type of equipment]

● Try to move the refrigerant pipes along with indoor unit. If the refrigerant pipes are too long, cut it from a position outside the house for easier removal. When the pipes are going to be used again, connect them with additional extension pipes by soldering. [For split type of equipment]

● For transportation, loading and unloading of equipment, please be careful and collision and drop are not allowed. It is forbidden to store the unit in a confined space or a space with ignition sources.



# 5. Maintenance

## 5.2 Attention

- 1) The user mustn't change the structure or wiring inside the unit.
- 2) The service and maintenance should be performed by qualified and well-trained technician. When the unit fails to run, please cut off power supply immediately.
- 3) The smart control system can automatically analyze various protection problems during daily use, and display the failure code on the controller. The unit may recover by itself. Under normal operation, the piping inside the unit don't need any maintenance.
- 4) In normal ambient conditions, the user only needs to clean the surface of the outdoor heat exchanger per month or quarter of a year.
- 5) If the unit runs in a dirty or oily environment, please clean the outdoor heat exchanger by professionals, using specified detergent, to ensure the performance and efficiency of the unit.
- 6) Please pay attention to the ambient environment, to check if the unit is installed firmly, or whether the air inlet and outlet of the outdoor unit is blocked.
- 7) Unless the water pump is damaged, no special service or maintenance should be taken to the water system inside the unit. It's recommended to clean water filter regularly or change it when it's very dirty or blocked.
- 8) If the unit will not be used in winter for a long time, please drain all the water inside the system, to prevent the water pipes from damage due to freezing.

## 5.3 Cleaning of water filter

The water filter should be cleaned according to the manual of water filter, to ensure the water flow of the water system. It is recommended that it be cleaned once in the first month, and then, once half a year.

## 5.4 Cleaning of plate heat exchanger

Thanks to the normally very high degree of turbulence in the heat exchanger, there is a self-cleaning effect in the channels. However, in some applications the fouling tendency can be very high, e.g. when using extremely hard water at high temperatures. In such cases it is always possible to clean the exchanger by circulating a cleaning liquid (CIP-Cleaning In Place). Use a tank with weak acid, 5% phosphoric acid or, if the exchanger is frequently cleaned, 5% oxalic acid. Pump the cleaning liquid through the exchanger. This work should be done by qualified person. For further information, please contact your supplier.

## 5.5 Gas charging

The refrigerant plays an important role in delivering energy in cooling or heating. Insufficient refrigerant affects directly efficiency of cooling and heating. Please pay attention to the following before adding refrigerant:

- 1) The work should be done by professionals.
- 2) If the system has not enough refrigerant inside, please check whether the system has leakage inside. If yes, please repair it before gas charging, otherwise unit will lack of refrigerant again after working for a short period.
- 3) Don't add too much refrigerant than required, or it may cause a lot of failures, such as high pressure and low efficiency.

## 5. Maintenance

- 4) This system uses R32 refrigerant. It is strictly forbidden to charge any refrigerant other than R32 into the system.
- 5) There must be no air in the refrigerant circulation, because air will cause abnormal high pressure, which will damage the gas piping and lower heating or cooling efficiency.
- 6) Refrigerant charge can only be done in cooling operation. Please proceed as followings:

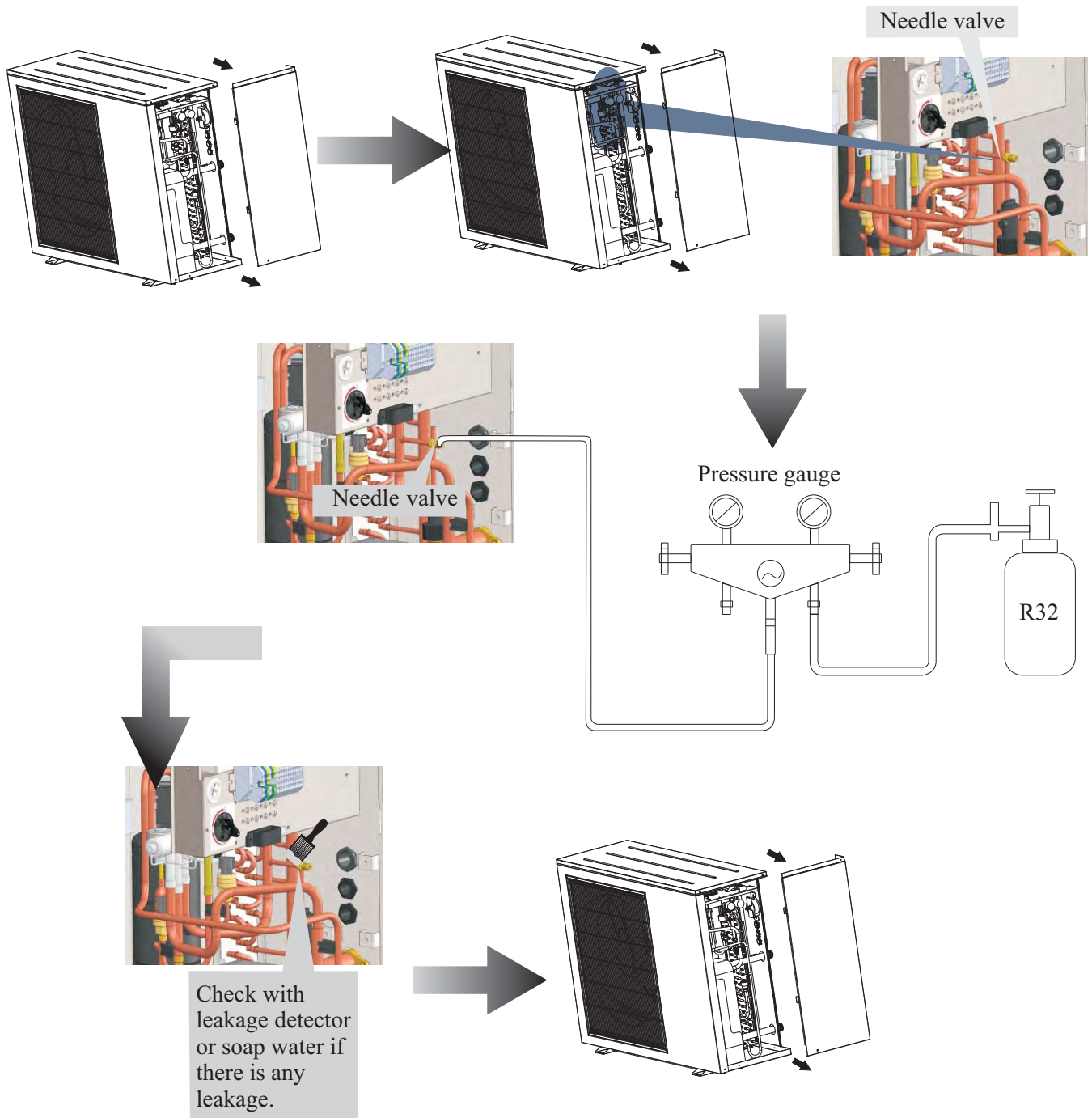

**Note:** Always use a weight scale to measure the gas amount charged into the unit.

# 5. Maintenance

## 5.6 Condenser coil

The condenser coils do not require any special maintenance, except when they are clogged by paper or any other foreign objects. Cleaning is by washing with detergent and water at low pressure, and then rinsing with clean water:

- 1) Before cleaning, make sure the unit is off.
- 2) Inner of the unit must be cleaned by qualified person.
- 3) Do not use gasoline, benzene, detergent etc. to clean the unit. And do not spray with insecticide. Otherwise the unit may be damaged. The cleanser special made for air conditioner cleaning is recommended.
- 4) Spray air conditioner cleanser into the coils. Let the cleaner sit for 5-8 minutes.
- 5) Then, spray the coil with clean water.
- 6) An old hairbrush works well for brushing surface dirt and lint off the fins. Brush in the same direction as the slots between the fins so the bristles go between the fins.
- 7) After cleaning, use a soft and dry cloth to clean the unit.

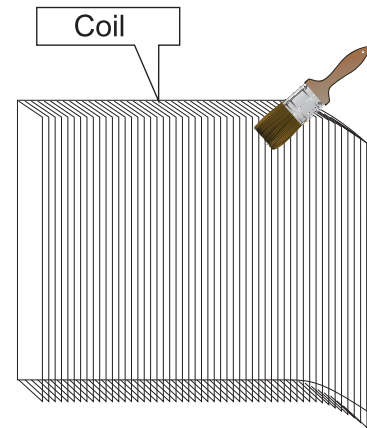

## 5.7 Service of indoor control unit

### 5.7.1 Maintenance of the electric components

- 1) Cut off the power supply, open the indoor control unit front panel and take off the electronic box cover.
- 2) Do necessary service to electronics.

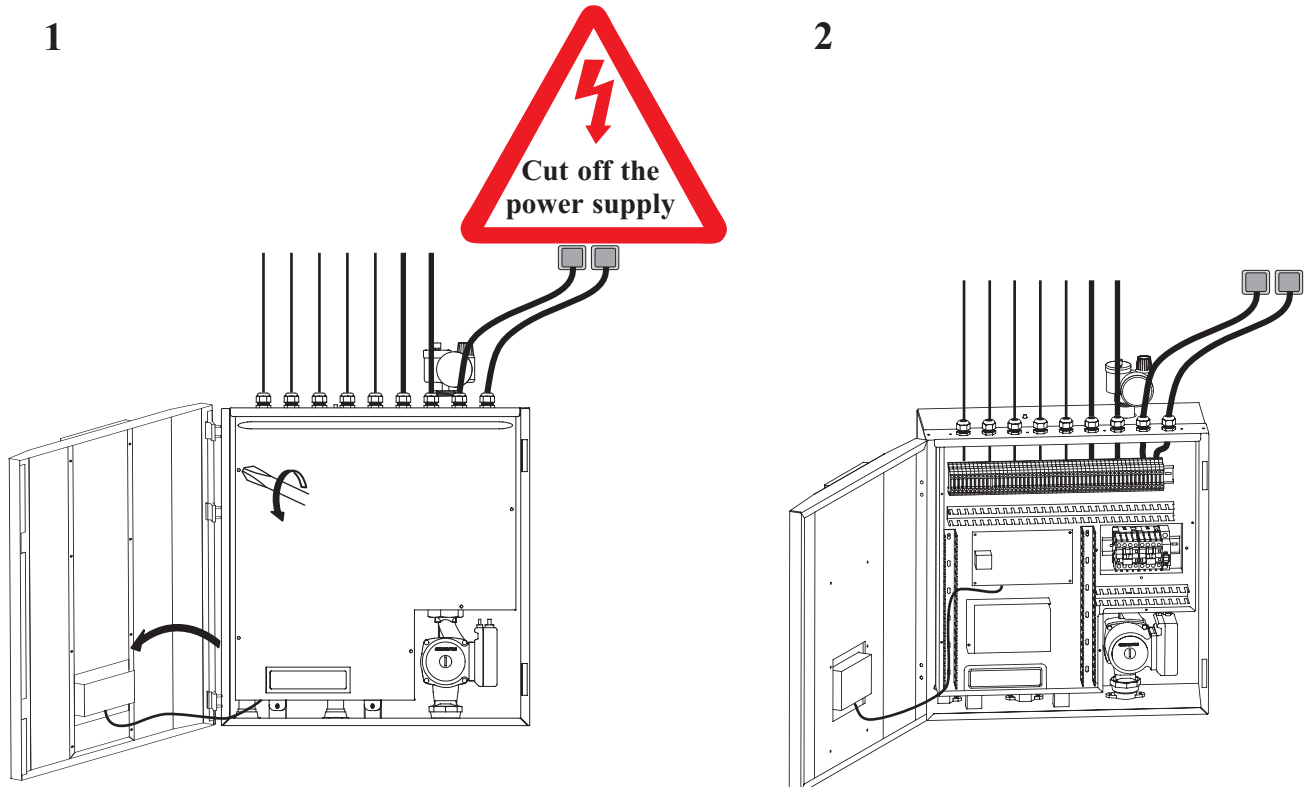

# 5. Maintenance

## 5.7.2 Replacement of water pump

- 1) Cut off the power supply, open the front panel and take off the electric box cover. Disconnect quick connector of water pump power cable, and pull out the signal cable connected to the indoor control PCB.
- 2) Cut water supply to the unit, and drain out water in the monoblock unit away. Use a wrench to loosen the connectors of water pump, and take the pump out from the unit.
- 3) Connect a new pump back to water system and electric system of the unit.

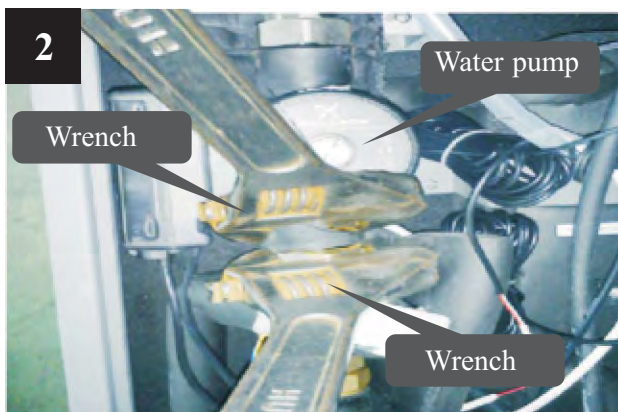
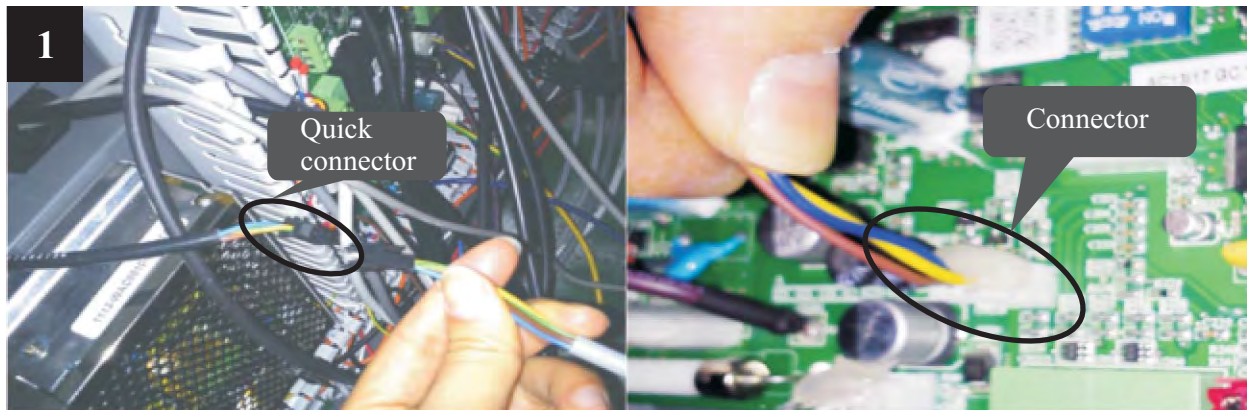

# 5. Maintenance

## 5.8 Service of monoblock outdoor unit

### 5.8.1 Maintenance of controller

- 1) Cut off the power supply, take off the top cover of the unit.
- 2) Take off the electric box cover.
- 3) Do necessary maintenance work to the controller of monoblock outdoor unit .

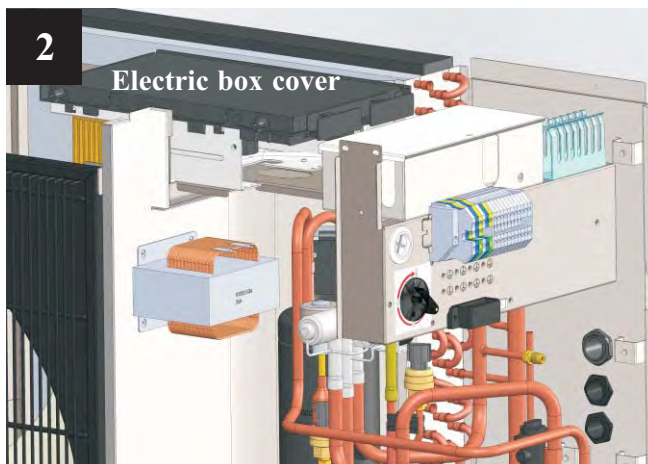
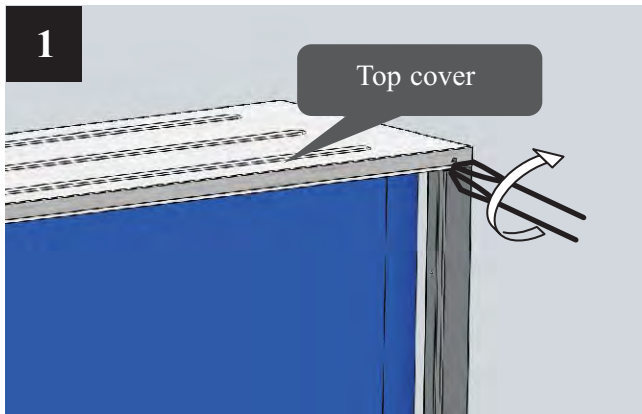

# 5. Maintenance

## 5.8.2 Replacement of fan motor

- 1) Cut off the power supply, take off screws of the front grill.
- 2) Use a wrench to loosen the nut for fan blade and take out the fan blade.
- 3) Take off the screws of fan motor.
- 4) Plug out power cable for fan motor from PCB.
- 5) Put the repaired or new fan motor back and connect all cables back.

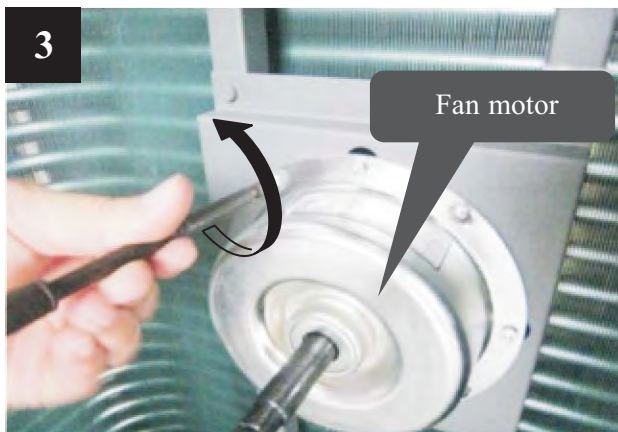

## 5. Maintenance

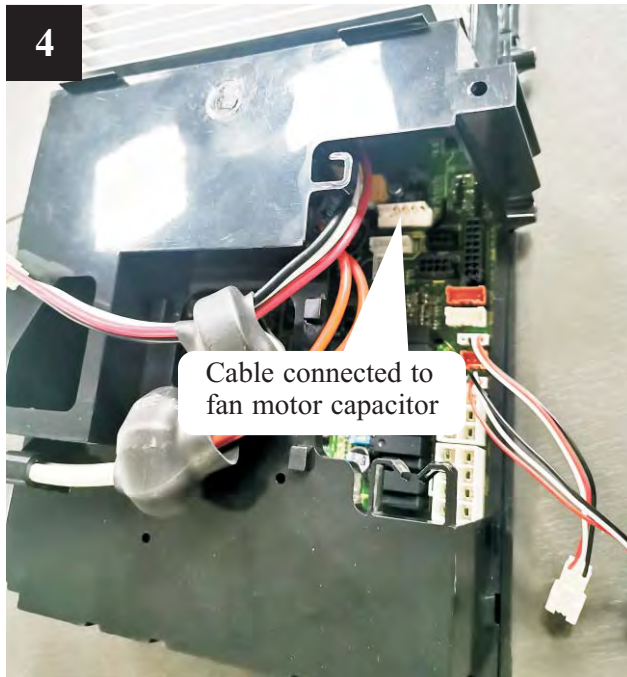

## 5. Maintenance

### 5.8.3 Replacement of bottom plate heater

- 1) Cut off the power supply, follows 4.7.2 to take out the fan blade.
- 2) Take off the fixture of bottom plate heater(see picture 1).
- 3) Disconnect the quick connector for bottom plate heater and take the heater out (see picture 2).
- 4) Put a new bottom plate heater back, and connect it to the quick connector(see picture 3).

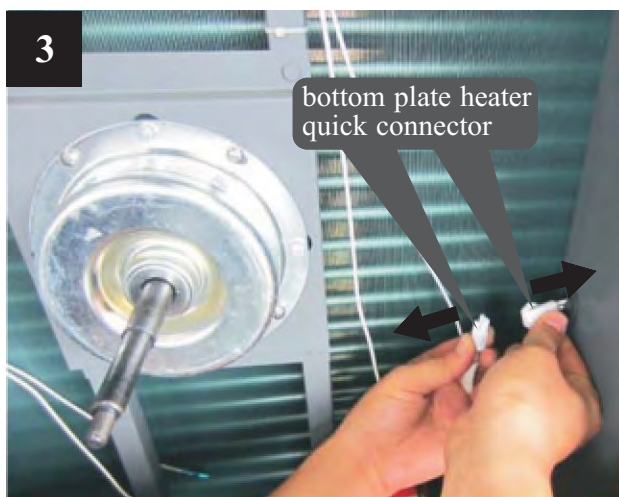
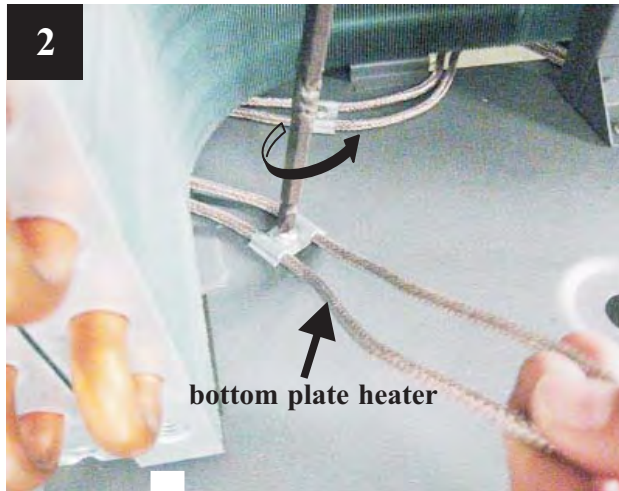



# 6. Attached drawing

## 6.1 Outlines and dimensions

— Indoor control unit  
Thermal 6/9/12

Unit:mm

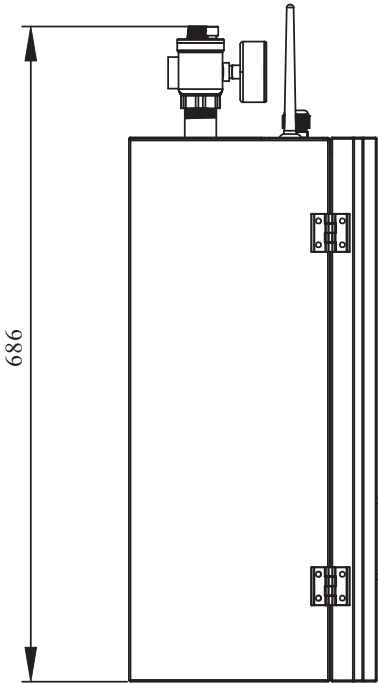
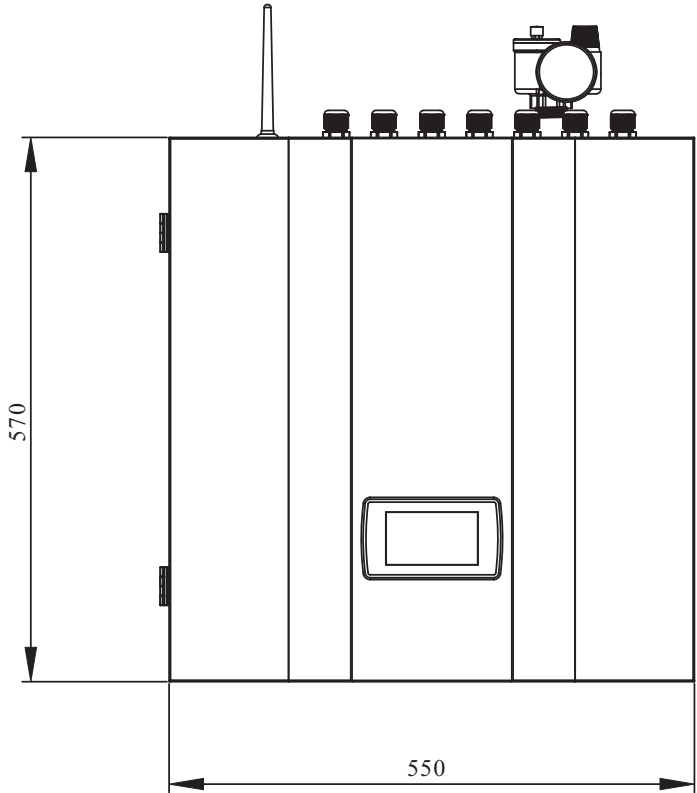
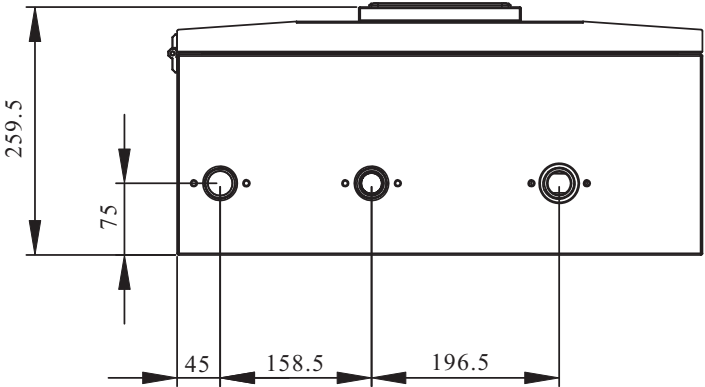

# 6. Attached drawing

— Monoblock unit  
Thermal 6

Unit:mm

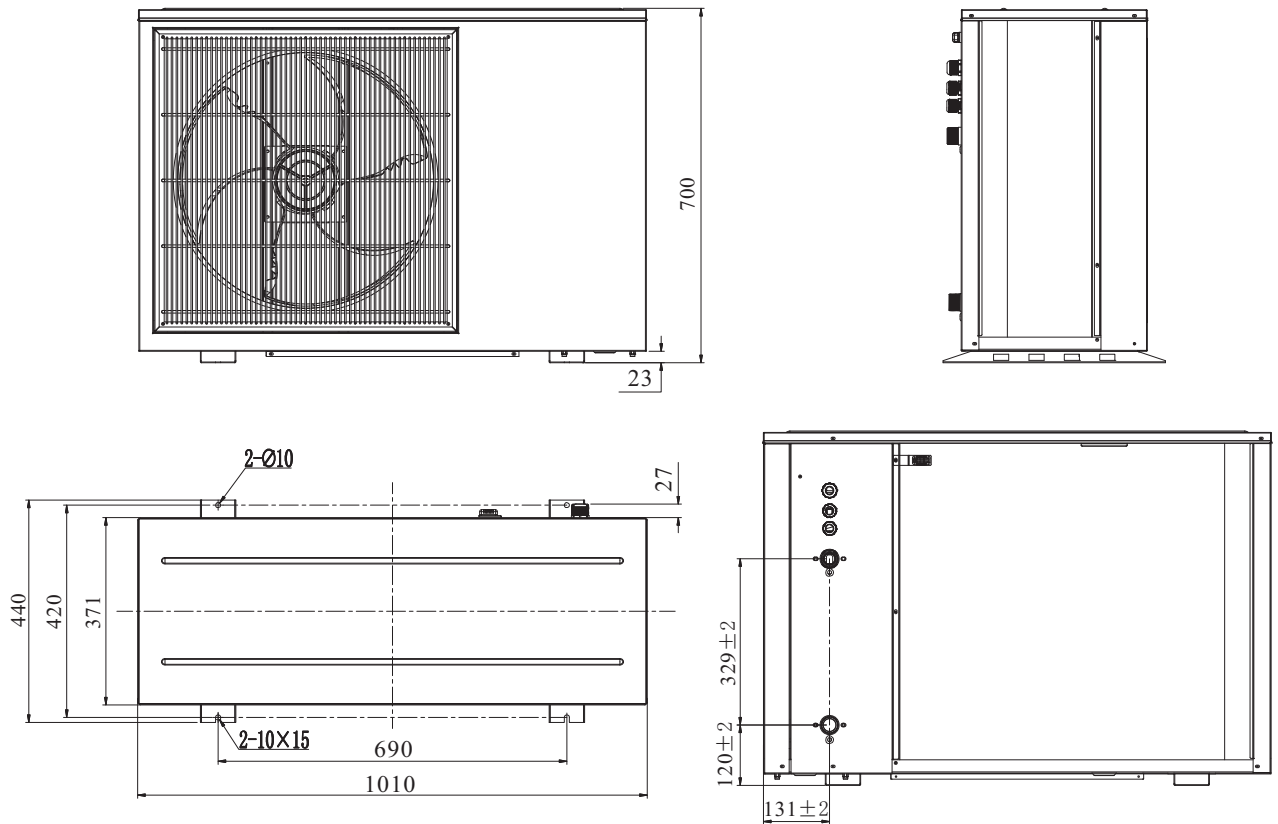

Thermal 9/12

Unit:mm

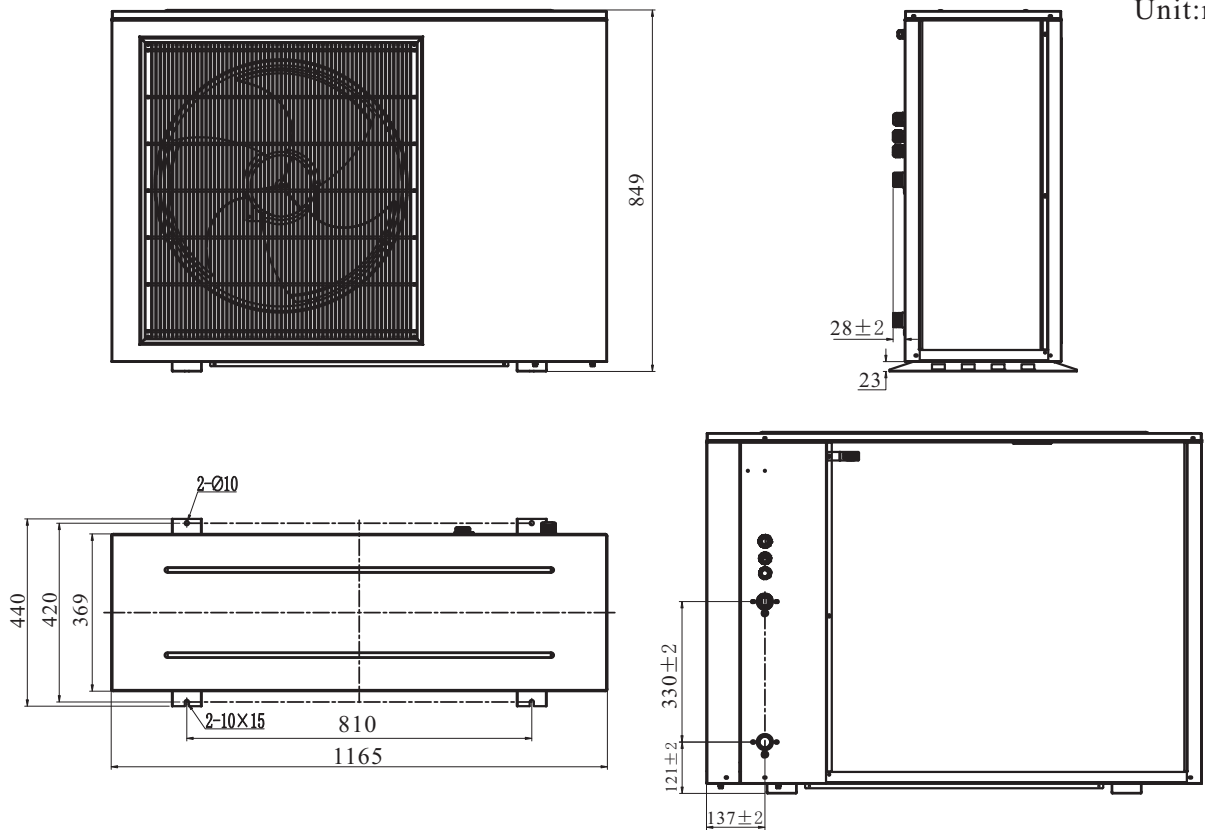

# 6. Attached drawing

## 6.2 Exploded view

— Indoor control unit

Thermal 6/9/12

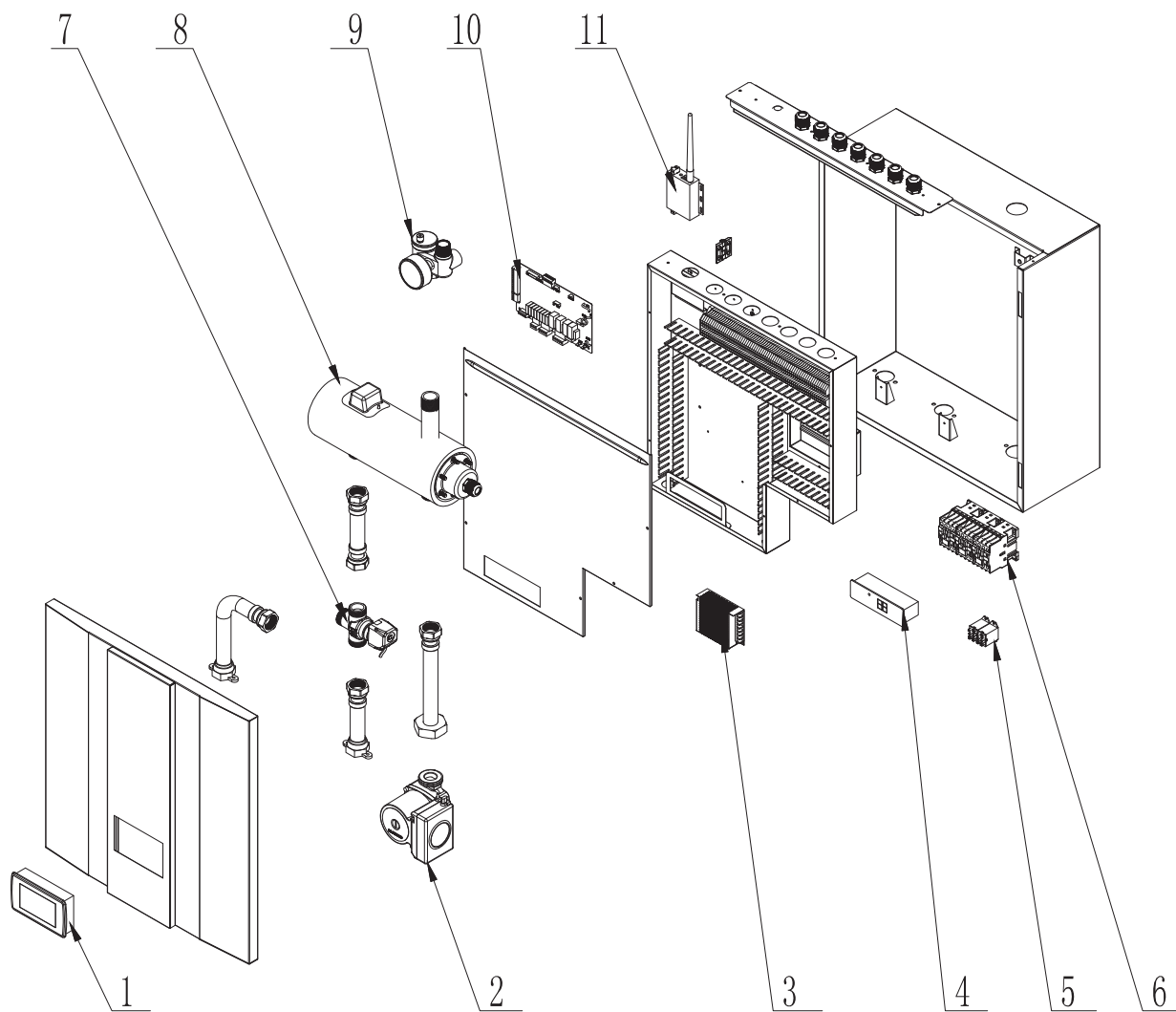

| NO | Name                | NO | Name                 |
|----|---------------------|----|----------------------|
| 1  | Operation panel     | 7  | Electric 3-way valve |
| 2  | Water pump          | 8  | Electric heater      |
| 3  | Switch power supply | 9  | Safety valve kit     |
| 4  | Digital thermostat  | 10 | Indoor PCB           |
| 5  | Contactor           | 11 | WIFI module          |
| 6  | Relay               |    |                      |

## 6. Attached drawing

— Monoblock unit  
Thermal 6/9/12

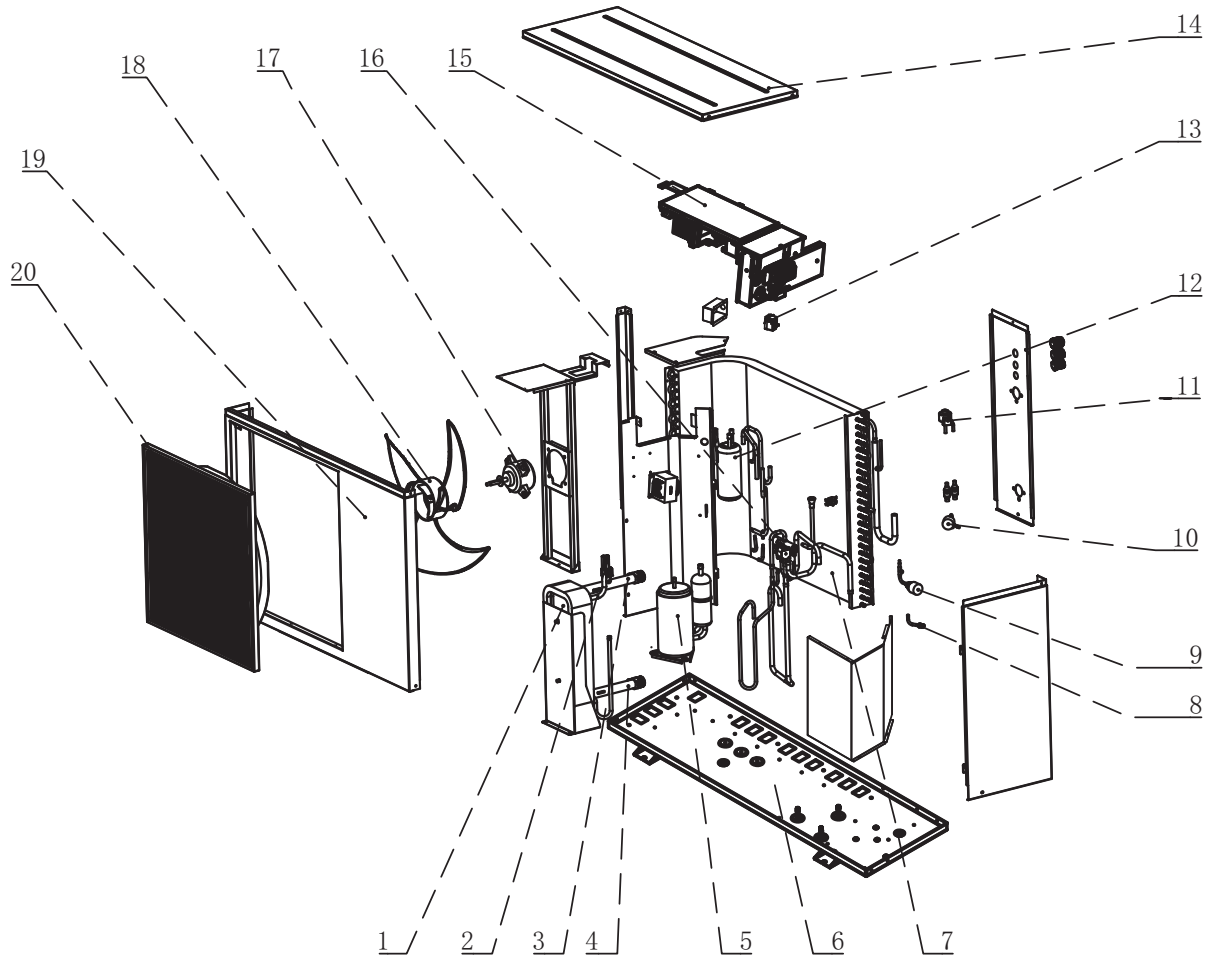

| NO. | name                 | NO. | name                  |
|-----|----------------------|-----|-----------------------|
| 1   | Plate Heat Exchanger | 11  | EEV                   |
| 2   | Flow Switch          | 12  | Gas Storage Tank      |
| 3   | Water Outlet Pipe    | 13  | Electrical Thermostat |
| 4   | Water Inlet Pipe     | 14  | Top Cover             |
| 5   | Compressor           | 15  | Control Box           |
| 6   | Bottom Plate         | 16  | 4-way Valve           |
| 7   | Evaporator Coil      | 17  | Fan Motor             |
| 8   | Needle Valve         | 18  | Fan Blade             |
| 9   | Low Pressure Sensor  | 19  | Front Panel           |
| 10  | High Pressure Sensor | 20  | Air Duct              |

# 6. Attached drawing

---

## 6.3 Wiring diagram

— Indoor control unit  
Thermal 6

**TAKE CARE!**  
The specifications are subject to change without prior notice.  
For actual specifications of the unit, please refer to the specification stickers on the unit.

## 6. Attached drawing

---

— Indoor control unit  
Thermal 9/12

**TAKE CARE!**

The specifications are subject to change without prior notice.  
For actual specifications of the unit, please refer to the specification stickers on the unit.

## 6. Attached drawing

---

—— **Monoblock unit**  
Thermal 6/9/12

TAKE CARE!

The specifications are subject to change without prior notice.

For actual specifications of the unit, please refer to the specification stickers on the unit.

# 6. Attached drawing

## 6.4 Appendix A: Wiring

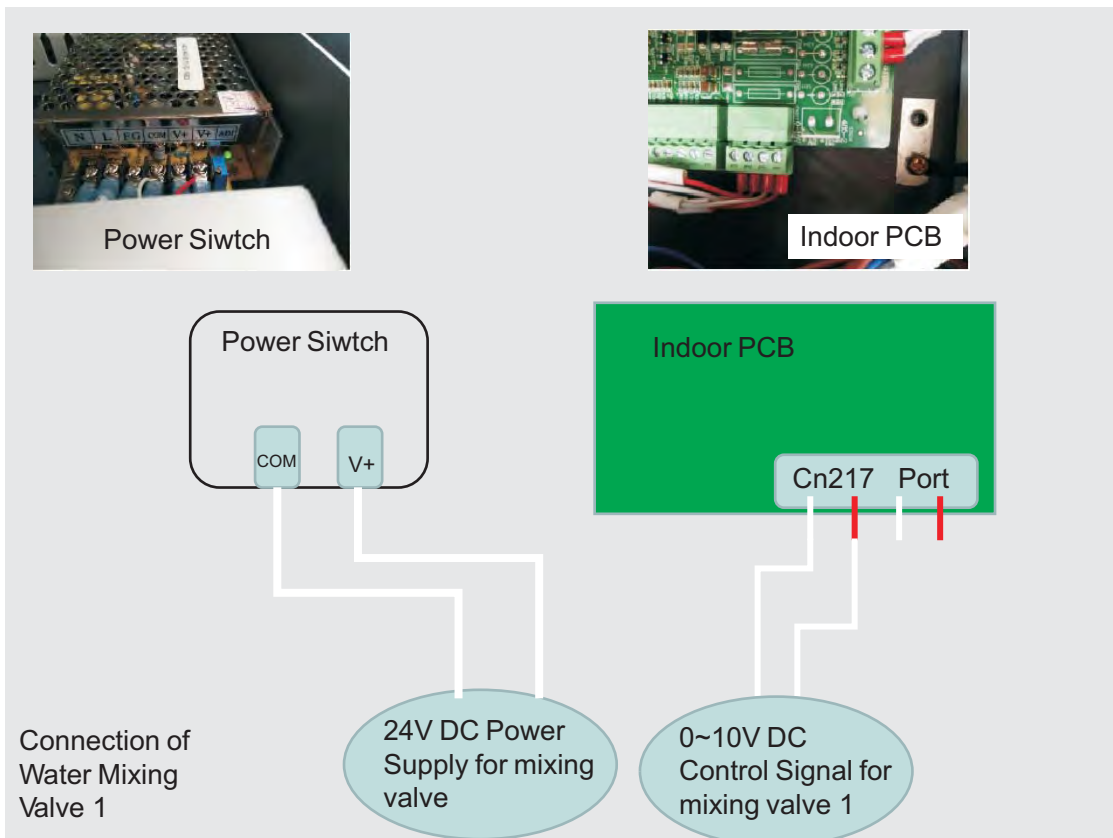
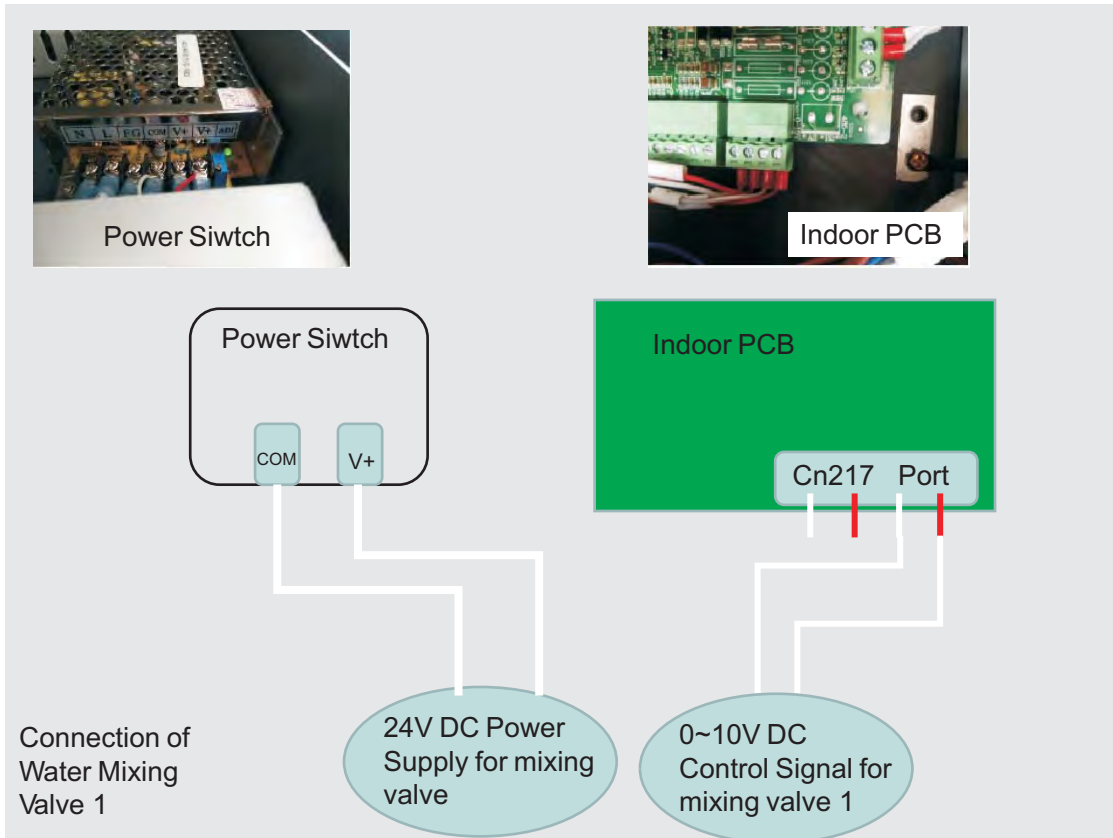



# 6. Attached drawing

## 6.4 Appendix A: Wiring

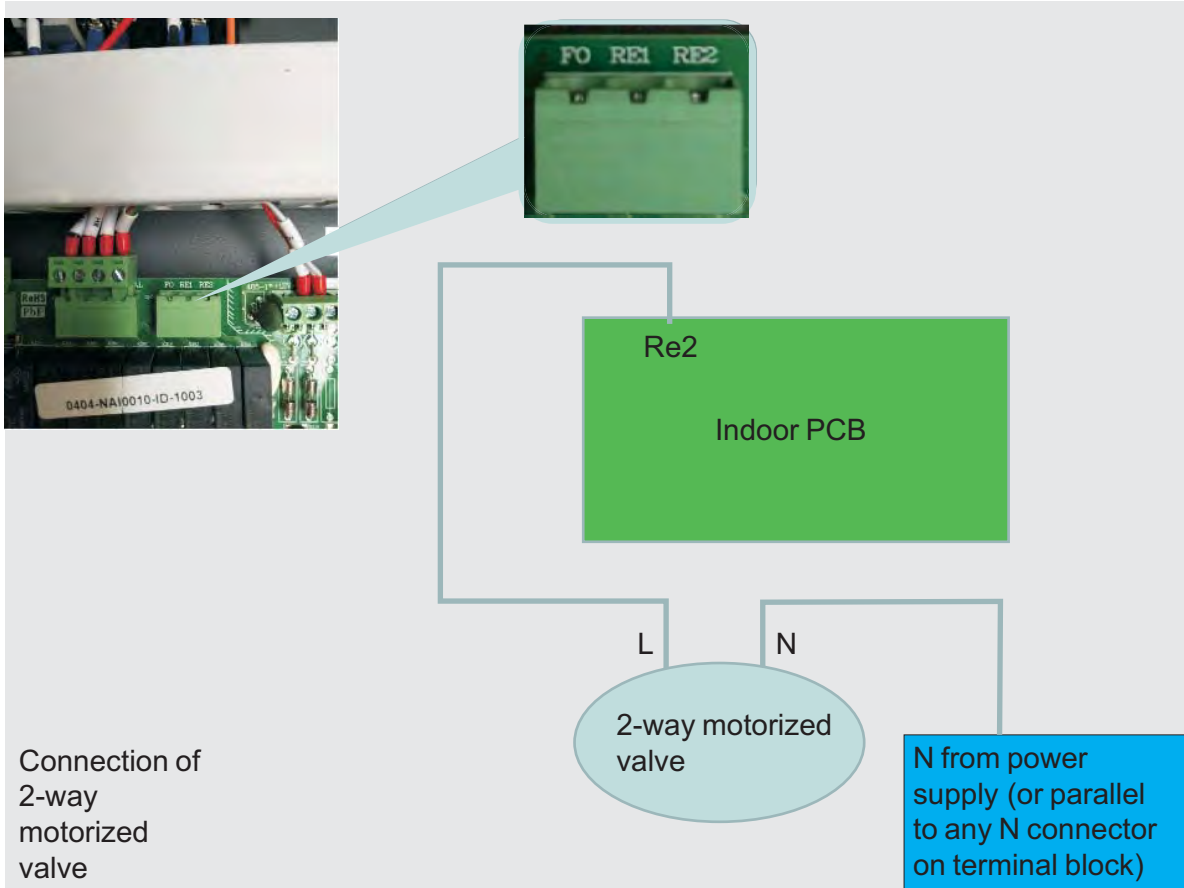

# 7. Cable specification

## (1) Single phase unit

| Nameplate maximum current | Phase line             | Earth line         | MCB  | Creepage protector     | Signal line            |
|---------------------------|------------------------|--------------------|------|------------------------|------------------------|
| No more than 10A          | 2 X 1.5mm <sup>2</sup> | 1.5mm <sup>2</sup> | 20A  | 30mA less than 0.1 sec | n X 0.5mm <sup>2</sup> |
| 10~16A                    | 2 X 2.5mm <sup>2</sup> | 2.5mm <sup>2</sup> | 32A  | 30mA less than 0.1 sec |                        |
| 16~25A                    | 2 X 4mm <sup>2</sup>   | 4mm <sup>2</sup>   | 40A  | 30mA less than 0.1 sec |                        |
| 25~32A                    | 2 X 6mm <sup>2</sup>   | 6mm <sup>2</sup>   | 40A  | 30mA less than 0.1 sec |                        |
| 32~40A                    | 2 X 10mm <sup>2</sup>  | 10mm <sup>2</sup>  | 63A  | 30mA less than 0.1 sec |                        |
| 40~63A                    | 2 X 16mm <sup>2</sup>  | 16mm <sup>2</sup>  | 80A  | 30mA less than 0.1 sec |                        |
| 63~75A                    | 2 X 25mm <sup>2</sup>  | 25mm <sup>2</sup>  | 100A | 30mA less than 0.1 sec |                        |
| 75~101A                   | 2 X 25mm <sup>2</sup>  | 25mm <sup>2</sup>  | 125A | 30mA less than 0.1 sec |                        |
| 101~123A                  | 2 X 35mm <sup>2</sup>  | 35mm <sup>2</sup>  | 160A | 30mA less than 0.1 sec |                        |
| 123~148A                  | 2 X 50mm <sup>2</sup>  | 50mm <sup>2</sup>  | 225A | 30mA less than 0.1 sec |                        |
| 148~186A                  | 2 X 70mm <sup>2</sup>  | 70mm <sup>2</sup>  | 250A | 30mA less than 0.1 sec |                        |
| 186~224A                  | 2 X 95mm <sup>2</sup>  | 95mm <sup>2</sup>  | 280A | 30mA less than 0.1 sec |                        |

## (2) Three phase unit

| Nameplate maximum current | Phase line             | Earth line         | MCB  | Creepage protector     | Signal line            |
|---------------------------|------------------------|--------------------|------|------------------------|------------------------|
| No more than 10A          | 3 X 1.5mm <sup>2</sup> | 1.5mm <sup>2</sup> | 20A  | 30mA less than 0.1 sec | n X 0.5mm <sup>2</sup> |
| 10~16A                    | 3 X 2.5mm <sup>2</sup> | 2.5mm <sup>2</sup> | 32A  | 30mA less than 0.1 sec |                        |
| 16~25A                    | 3 X 4mm <sup>2</sup>   | 4mm <sup>2</sup>   | 40A  | 30mA less than 0.1 sec |                        |
| 25~32A                    | 3 X 6mm <sup>2</sup>   | 6mm <sup>2</sup>   | 40A  | 30mA less than 0.1 sec |                        |
| 32~40A                    | 3 X 10mm <sup>2</sup>  | 10mm <sup>2</sup>  | 63A  | 30mA less than 0.1 sec |                        |
| 40~63A                    | 3 X 16mm <sup>2</sup>  | 16mm <sup>2</sup>  | 80A  | 30mA less than 0.1 sec |                        |
| 63~75A                    | 3 X 25mm <sup>2</sup>  | 25mm <sup>2</sup>  | 100A | 30mA less than 0.1 sec |                        |
| 75~101A                   | 3 X 25mm <sup>2</sup>  | 25mm <sup>2</sup>  | 125A | 30mA less than 0.1 sec |                        |
| 101~123A                  | 3 X 35mm <sup>2</sup>  | 35mm <sup>2</sup>  | 160A | 30mA less than 0.1 sec |                        |
| 123~148A                  | 3 X 50mm <sup>2</sup>  | 50mm <sup>2</sup>  | 225A | 30mA less than 0.1 sec |                        |
| 148~186A                  | 3 X 70mm <sup>2</sup>  | 70mm <sup>2</sup>  | 250A | 30mA less than 0.1 sec |                        |
| 186~224A                  | 3 X 95mm <sup>2</sup>  | 95mm <sup>2</sup>  | 280A | 30mA less than 0.1 sec |                        |

When the unit will be installed at outdoor, Please use the cable which can against UV.



Thank you for choosing our quality product.  
Please read this manual carefully before use and  
follow the instructions to operate the unit in order  
to prevent damages on the device or injuries to staff.

Specifications are subject to change with product  
improvements without prior notice. Please refer to the  
specification sticker on the unit for upgraded specifications.